

Paso Doble Stool design Stefano Giovannoni • image p-20

Stacking stool.

Also available with arms.

Year of production: 2010.

Material: frame in aluminium.

Arms and foot-rest in die-cast aluminium painted in polyester powder or polished.

Seat in polyester-vinyl polymer fabric, or in polyester-vinyl polymer and polyester-cotton fabric, or in leather.

Taburete apilable.

Versión con brazos.

Año de producción: 2010.

Material: estructura en perfil de aluminio. Brazos y reposapiés en profusión de aluminio barnizados poliéster o brillantes. Asiento en tela de hilado poliéster-polímero vinílico o en tela de hilado poliéster-polímero vinílico y poliéster-algodón o en piel.

Chaise empilable.

Disponibile aussi avec accoudoirs.

Année de production: 2010.

Matériaux: structure en aluminium. Accoudoirs et repose-pieds en fonte d'aluminium verni en polyester ou poli. Assise en tissu polyester-polymère vinilyque ou en tissu polyester-polymère vinilyque et polyester-coton ou en cuir.

Stuhl, stapelbar.

Auch mit Armlehnen lieferbar.

Erstproduktion: 2010.

Material: Gestell aus Aluminium.

Armlehnen und Fußstütze aus Aluminium-Druckguss polyesterlackiert oder poliert. Sitz aus Polyester-Vinylpolymere Stoff, oder aus Polyester-Vinylpolymere und Polyester-Baumwolle Stoff, oder aus Leder.











Sgabello impilabile.

Versione anche con braccioli.





Anno di produzione: 2010.

Materiali: struttura in profilato di alluminio. Braccioli e poggiatesta in pressofusione di alluminio verniciati poliestere o lucidi. Sedile in tessuto di filati poliestere-polimero vinilico, o in tessuto di filati poliestere-polimero vinilico e poliestere-cotone, o in cuoio.

FINISHES (indoor use)

-  black frame
-  black 1754 C seat (polyester-vinyl polymer and polyester-cotton fabric)
-  black 1754 C seat (leather)
-  polished frame
-  purple 1484 C seat (polyester-vinyl polymer and polyester-cotton fabric)
-  green 1558 C seat (polyester-vinyl polymer and polyester-cotton fabric)
-  orange 1659 C seat (polyester-vinyl polymer and polyester-cotton fabric)
-  black 1754 C seat (polyester-vinyl polymer and polyester-cotton fabric)
-  white-black mélange 1762 C seat (polyester-vinyl polymer and polyester-cotton fabric)
-  black 1754 C seat (leather)

FINISHES (outdoor use)

-  white frame
-  white 1736 C seat (polyester-vinyl polymer fabric)
-  black frame
-  black 1754 C seat (polyester-vinyl polymer fabric)

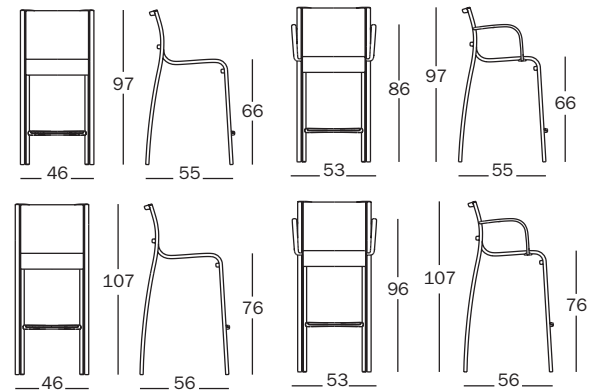
Pipe Chair design Jasper Morrison • image p-34

Stacking chair.

Also available with arms.

Year of production: 2009.

Material: frame in polished aluminium tube or painted in polyester powder. Seat and back in punched aluminium plate polished or painted in polyester powder, or in beech plywood.

Silla apilable.

Versión con brazos.

Año de producción: 2009.

Material: estructura en tubo de aluminio brillante o barnizado poliéster. Asiento y respaldo en chapa de aluminio perforada brillante o barnizada poliéster o en chapado haya.

oder polyesterlackiert.

Sitz und Rückenlehne aus Aluminiumlochbech, poliert oder polyesterlackiert, oder aus Buchenschichtholz.

Sedia impilabile.

Versione anche con braccioli.

Anno di produzione: 2009.

Materiali: struttura in tubo di alluminio lucido o verniciato poliestere. Sedile e schienale in lamiera di alluminio forata lucida o verniciata poliestere, oppure in impiallacciato di faggio.

Chaise empilable.

Disponibile aussi avec accoudoirs.

Année de production: 2009.

Matériaux: structure en tube d'aluminium poli ou verni en polyester. Assise et dossier en tôle d'aluminium percée poli ou verni en polyester, ou en hêtre multiplis.





FINISHES (indoor use)

-  polished aluminium

COLOURS (outdoor use)

-  green 5035
-  white 5107
-  black 5130

COUPLINGS (outdoor use)

-  white 5107 (frame)
-  light-coloured beech (seat and back)
-  black 5130 (frame)
-  dark-coloured beech (seat and back)

Stuhl, stapelbar.

Auch mit Armlehnen lieferbar.

Erstproduktion: 2009.

Material: Gestell aus Aluminiumrohr poliert

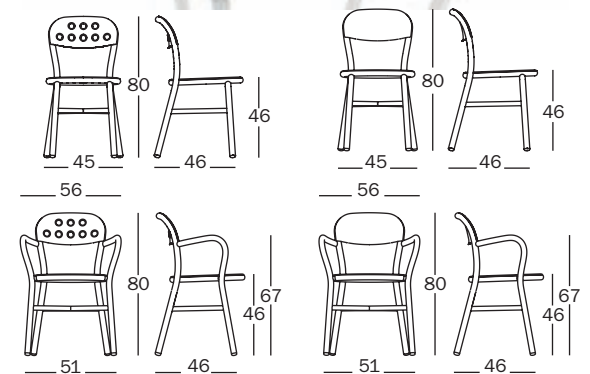

Pipe Stool design Jasper Morrison • image p-44

Stools.

Year of production: 2009.
Material: frame in polished aluminium tube or painted in polyester powder. Seat in punched aluminium plate polished or painted in polyester powder, or in beech plywood.

Taburetes.

Año de producción: 2009.
Material: estructura en tubo de aluminio brillante o barnizado poliéster. Asiento en chapa de aluminio perforada brillante o barnizada poliéster o en chapado haya.

Tabourets.

Année de production: 2009.
Matériaux: structure en tube d'aluminium poli ou verni en polyester. Assise en tôle d'aluminium percée poli ou verni en polyester, ou en hêtre multiplis.

Hocker.

Erstproduktion: 2009.
Material: Gestell aus Aluminiumrohr poliert oder polyesterlackiert. Sitz aus Aluminiumlochblech poliert oder polyesterlackiert, oder aus Buchenschichtholz.

Sgabelli.

Anno di produzione: 2009.
Materiali: struttura in tubo di alluminio lucido o verniciato poliester. Sedile in lamiera di alluminio forata lucida o verniciata poliester, oppure in impiallacciato di faggio.

FINISHES (indoor use)

polished aluminium

COLOURS (outdoor use)

green 5035

white 5107

black 5130

COUPLINGS (outdoor use)

white 5107 (frame)

light-coloured beech (seat)

black 5130 (frame)

dark-coloured beech (seat)

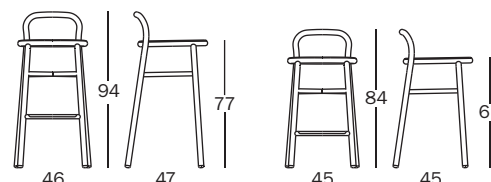

Pipe Table design Jasper Morrison • image p-40

Tables.

Year of production: 2009.
Material: base in steel plate. Frame in steel, cataphoretically treated and painted in polyester powder. Top in beech plywood. Suitable for outdoor use.

Mesas.

Año de producción: 2009.
Material: base en chapa de acero, estructura en acero tratado con titanio al fluor y barnizado poliéster. Sobre en chapado haya. Adaptadas para el exterior.

Tables.

Année de production: 2009.
Matériaux: base en tôle d'acier. Structure en acier traité en cataphorèse et verni en polyester. Plateau en hêtre multiplis. Conçues pour l'extérieur.

Tische.

Erstproduktion: 2009.
Material: Fuss aus Stahlblech. Gestell aus rostschutzbehandeltem, polyesterlackiertem Stahl. Tischplatte aus Buchenschichtholz. Auch für den Aussenbereich geeignet.

Tavoli.

Anno di produzione: 2009.
Materiali: base in lamiera di acciaio, struttura in acciaio trattato cataforesi e verniciato poliester. Piano in impiallacciato di faggio. Adatti anche per esterni.

COUPLINGS (outdoor use)

white 5107 (frame)

light-coloured beech (top)

black 5130 (frame)

dark-coloured beech (top)

