

Bombo Chair design Stefano Giovannoni • image p-182

Swivel chair.

Year of production: 1999.
Adjustable in height with gas piston. Fixed height version also available, with optional self-returning mechanism.
Material: base in chromed steel. Seat in standard injection moulded ABS.

Silla giratoria.

Año de producción: 1999.
Versión con altura fija o regulable con pistón de gas. La versión con altura fija está también disponible con mecanismo de retorno.
Material: base en acero cromado. Asiento en ABS estampado con inyección standard.

Chaise pivotante.

Année de production: 1999.
Version à hauteur fixe ou réglable avec piston à gaz. Version à hauteur fixe disponible aussi avec mécanisme à mémoire de position. Matériaux: base en acier chromé. Assise en ABS moulé par injection standard.

Stuhl, drehbar.

Erstproduktion: 1999.
Pneumatisch höhenverstellbar. Auch in fixer Höhe lieferbar.

Optional mit drehbar gelagertem Sitz (Rückkehrmechanismus).
Material: Gestell aus verchromtem Stahl. Sitz aus ABS, hergestellt im Standard-Einspritzverfahren.

Sedia girevole.

Anno di produzione: 1999.
Versione ad altezza fissa o regolabile in altezza con pistone a gas. La versione ad altezza fissa è disponibile anche con meccanismo di ritorno. Materiali: base in acciaio cromato, sedile in ABS stampato ad iniezione standard.

MATT COLOURS

	ivory 1020 C
	orange 1050 C
	green 1340 C
	brown 1400 C
	grey anthracite 1420 C
	blue 1500 C
	lilac 1600 C
	blue ultramarine 1620 C
	white 1690 C
	metallic silver 1760C
	gold 1810 C
	copper 1820 C

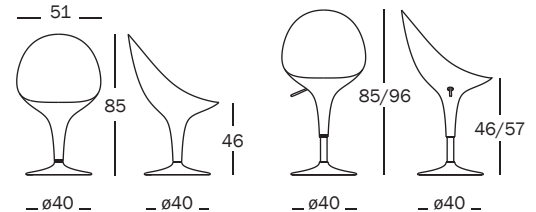
Bombo Chair on Wheels design Stefano Giovannoni • image p-183

Swivel chair on 5 star base.
Year of production: 2000.
Adjustable in height with gas piston. Material: base in stainless steel. Seat in standard injection moulded ABS.
Wheels in polyamide.

Silla giratoria con 5 ruedas.
Año de producción: 2000.
Regulable en altura con pistón de gas. Material: base en acero inoxidable. Asiento en ABS estampado con inyección standard. Ruedas en poliamida.

Chaise pivotante sur 5 roulettes.

Année de production: 2000.
Réglable en hauteur avec piston à gaz. Matériaux: piétement à 5 branches en acier inoxydable. Assise en ABS moulé par injection standard. Roulettes en polyamide.

Stuhl auf 5 Rollen, drehbar.
Erstproduktion: 2000.
Pneumatisch höhenverstellbar.
Material: Fußkreuz aus rostfreiem Stahl. Sitz aus ABS, hergestellt im Standard-Einspritzverfahren. Rollen aus Polyamid.

Sedia girevole su 5 ruote.
Anno di produzione: 2000.
Regolabile in altezza con pistone a gas. Materiali: razze in acciaio inossidabile, sedile in ABS stampato ad iniezione standard, ruote in poliammide.

MATT COLOURS

	ivory 1020 C
	orange 1050 C
	green 1340 C
	brown 1400 C
	grey anthracite 1420 C
	blue 1500 C
	lilac 1600 C
	blue ultramarine 1620 C
	white 1690 C
	metallic silver 1760C
	gold 1810 C
	copper 1820 C

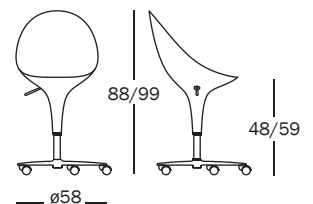

Big Bombo design Stefano Giovannoni • image p-184

Tables.

Year of production: 2002/2003.

Material: weighted base in chromed steel. Frame and top in acrylic painted polyurethane.

Mesas.

Año de producción:

2002/2003.

Material: base en acero cromado lastrada, estructura y sobre en poliuretano barnizado acrílico.

Tables.

Année de production:

2002/2003.

Matériaux: base en acier chromé lestée. Structure et plateau en polyuréthane verni en acrylique.

Tische.

Erstproduktion: 2002/2003.

Material: Fuß aus verchromtem Stahl mit Gewicht beschwert. Gestell und Tischplatte aus acryllackiertem Polyurethan.



Tavoli.

Anno di produzione:

2002/2003.

Materiali: base in acciaio cromato zavorrata, struttura e piano in poliuretano verniciato acrilico.

MATT COLOURS

-  grey anthracite 1420 C
-  white 1690 C
-  metallic silver 1760 C



Bombo Table design Stefano Giovannoni • image p-186

Table.

Year of production: 1998.

Adjustable in height with gas piston. Also fixed height versions available. Material: base in chromed steel, top in standard injection-moulded ABS.

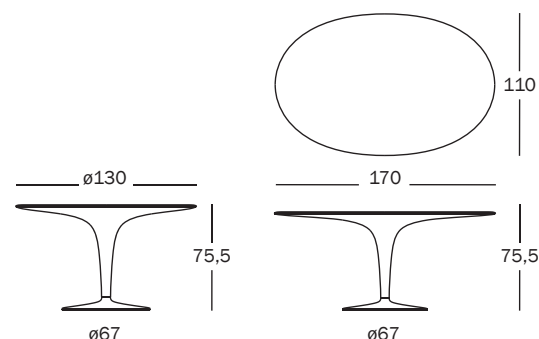
Regolabile in altezza con pistone a gas o ad altezze fisse (due altezze standard).

Materiali: base in acciaio cromato, piano in ABS stampato ad iniezione standard.

Mesa.

Año de producción: 1998.

Regulable en altura con pistón de gas o altura fija. Material: base en acero cromado, sobre en ABS estampado con inyección standard.

Table.

Année de production: 1998.

Réglable en hauteur avec piston à gaz ou à hauteur fixe. Matériaux: base en acier chromé, plateau en ABS moulé par injection standard.

MATT COLOURS (adjustable height)

-  ivory 1020 C
-  orange 1050 C
-  green 1340 C
-  brown 1400 C
-  grey anthracite 1420 C
-  blue 1500 C
-  lilac 1600 C
-  blue ultramarine 1620 C
-  white 1690 C
-  metallic silver 1760 C
-  gold 1810 C
-  copper 1820 C

MATT COLOURS (fixed height)

-  grey anthracite 1420 C
-  white 1690 C
-  metallic silver 1760 C
-  gold 1810 C
-  copper 1820 C

Tisch.

Erstproduktion: 1998.

Pneumatisch höhenverstellbar. Auch in fixer Höhe lieferbar (2 Standardhöhen). Material: Gestell aus verchromtem Stahl. Tischplatte aus ABS, hergestellt im Standard-Einspritzverfahren.

Tavolo.

Anno di produzione: 1998.

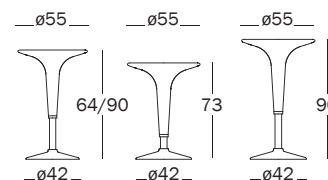

Little Bombo Table design Stefano Giovannoni • image p-187

Small table.
Year of production: 2001.
Adjustable in height with gas piston. Material: base in chromed steel. Top in standard injection moulded ABS.

stampato ad iniezione standard.

Mesita.
Año de producción: 2001.
Regulable en altura con pistón de gas. Material: base en acero cromado. Sobre en ABS estampado con inyección standard.

Guéridon.
Année de production: 2001.
Réglable en hauteur avec piston à gaz. Matériaux: base en acier chromé. Plateau en ABS moulé par injection standard.

Kleiner Tisch.
Erstproduktion: 2001.
Pneumatisch höhenverstellbar. Material: Gestell aus verchromtem Stahl. Tischplatte aus ABS, hergestellt im Standard-Einspritzverfahren.

Tavolino.
Anno di produzione: 2001.
Regolabile in altezza con pistone a gas. Materiali: base in acciaio cromato, piano in ABS

MATT COLOURS

-  grey anthracite 1420 C
-  white 1690 C
-  metallic silver 1760 C

Bombo Stool design Stefano Giovannoni • image p-188

Swivel bar stool.
Year of production: 1997.
Adjustable in height with gas piston. Also fixed height versions available. Material: base in chromed steel. Seat in standard injection-moulded ABS.

con pistone a gas o ad altezze fisse (due altezze standard).
Materiali: base in acciaio cromato, sedile in ABS stampato ad iniezione standard.

Taburet giratorio.
Año de producción: 1997.
Regulable en altura con pistón de gas o alturas fijas. Material: base en acero cromado, asiento en ABS estampado con inyección standard.

Tabouret pivotant.
Année de production: 1997.
Réglable en hauteur avec piston à gaz ou à hauteur fixe. Matériaux: base en acier chromé, assise en ABS moulé par injection standard.

Hocker, drehbar.
Erstproduktion: 1997.
Pneumatisch höhenverstellbar. Auch in fixer Höhe lieferbar (2 Standardhöhen). Material: Gestell aus verchromtem Stahl. Sitz aus ABS, hergestellt im Standard-Einspritzverfahren.

Sgabello girevole.
Anno di produzione: 1997.
Versioni: regolabile in altezza

MATT COLOURS (adjustable height)

-  ivory 1020 C
-  orange 1050 C
-  red 1125 C
-  green 1340 C
-  brown 1400 C
-  grey anthracite 1420 C
-  blue 1500 C
-  lilac 1600 C
-  blue ultramarine 1620 C
-  white 1690 C
-  metallic silver 1760 C
-  gold 1810 C
-  copper 1820 C

MATT COLOURS (fixed height)

-  grey anthracite 1420 C
-  white 1690 C
-  metallic silver 1760 C
-  gold 1810 C
-  copper 1820 C

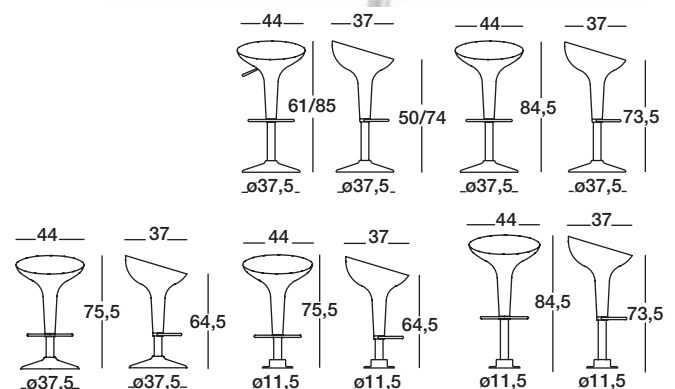

Special Bombo design Stefano Giovannoni • image p-190

Swivel bar stool.
Year of production: 2003.
Adjustable in height with gas piston. Also fixed height versions available.
Material: base in stainless steel.
Seat in standard injection-moulded ABS, glossy.
Flame-retardant.

Taburete giratorio.
Año de producción: 2003.
Regulable en altura con pistón de gas o alturas fijas.
Material: base y columna en acero inoxidable. Asiento en ABS brillante estampado con inyección standard. Producto ignífugo.

Tabouret pivotant.
Année de production: 2003.
Réglable en hauteur avec piston à gaz ou à hauteurs fixes.
Matériaux: base en acier inoxydable. Assise en ABS brillant moulé par injection standard. À combustion retardée.

Hocker, drehbar.
Erstproduktion: 2003.
Pneumatisch höhenverstellbar. Auch in fixer Höhe lieferbar (2 Standardhöhen).
Material: Gestell, Fußstütze und Hebel aus rostfreiem Stahl. Sitz aus ABS, glänzend. Hergestellt

im Standard-Einspritzverfahren. Feuerhemmend.

Sgabello girevole.
Anno di produzione: 2003.
Versioni: regolabile in altezza con pistone a gas o ad altezze fisse (due altezze standard).
Materiali: base, colonna, poggiatesta e maniglia in acciaio inossidabile, sedile in ABS lucido. Prodotto ignifugo.

GLOSSY COLOURS
 red 1128 C
 white 1673 C
 black 1763 C

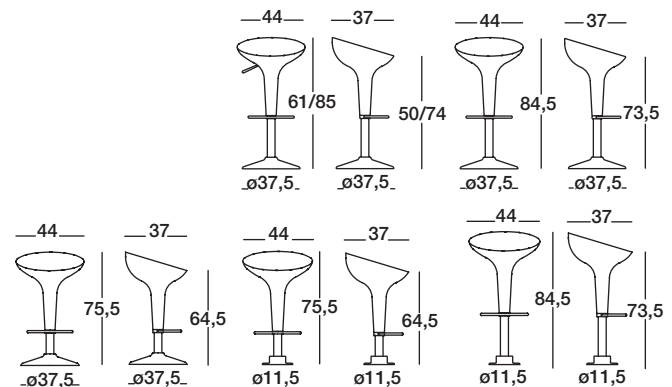
AI Bombo design Stefano Giovannoni • image p-191

Swivel bar stool.
Year of production: 2002.
Adjustable in height with gas piston. Also fixed height versions available. Material: base and frame in stainless steel. Seat in polished die-cast aluminium.
Flame-retardant.

Taburete giratorio.
Año de producción: 2002.
Regulable en altura con pistón de gas o alturas fijas. Material: base y columna en acero inoxidable, asiento en profusión de aluminio brillante. Producto ignífugo.

Tabouret pivotant.
Année de production: 2002.
Réglable en hauteur avec piston à gaz ou versions à hauteur fixe. Matériaux: base et colonne en acier inoxydable. Assise en fonte d'aluminium poli. Non feu.

Hocker, drehbar.
Erstproduktion: 2002.
Pneumatisch höhenverstellbar. Auch in fixer Höhe lieferbar (2 Standardhöhen). Material: Gestell, Fußstütze und Hebel aus rostfreiem Stahl. Sitz aus Aluminium-Druckguss, poliert. Feuerbeständig.

Sgabello girevole.
Anno di produzione: 2002.
Versioni: regolabile in altezza con pistone a gas o ad altezze fisse (due altezze standard).
Materiali: base, colonna, poggiatesta e maniglia in acciaio inossidabile, sedile in pressofusione di alluminio lucido. Prodotto ignifugo.

