

Magis HOME — Collection book 2017

H O M
E I B O
O
K



Magis HOME – Collection book 2017

HO M
E – BO
O
K



Collection book ^{04 → 73}

Cyborg + Cuckoo – The Wild Bunch
+ Ettore + Milà + Officina +
Sam Son + Stanley
+ Substance + Traffic + Troy
+ XZ3

Technical information ^{75 → 107}

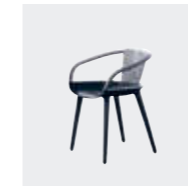

Cyborg
76

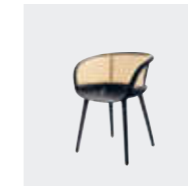

Cyborg
77

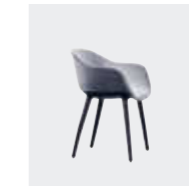

Cyborg
78



Milà
79

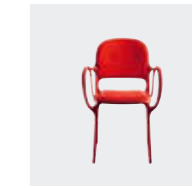

Milà
80

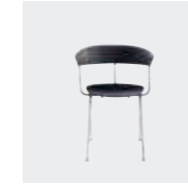

Officina
81



Stanley
82



Substance
83→85



Substance
83→85

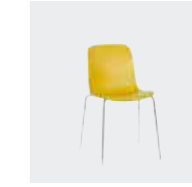

Substance
83→85

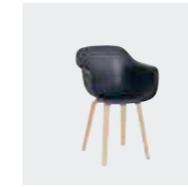

Substance
83→85



Substance
83→85



Substance
83→85



Troy
86→90



Troy
86→90



Officina
91



Sam Son
92

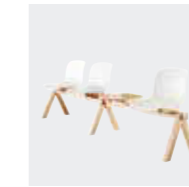

Troy
93



Cuckoo - The Wild
Bunch
94



Traffic
95

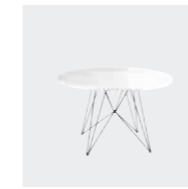

XZ3
96-97



Officina
98

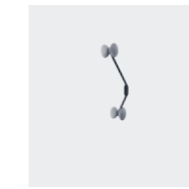

Officina
99



Ettore
100



Officina
101



Officina
102



Officina
103



Officina
104



Officina
105

Milà chair
design Jaime Hayón, 2016
→ more info / p. 79



Milà chair
design Jaime Hayón, 2016
→ more info / p. 79

Baguette table
design Ronan & Erwan Bouroullec, 2011



Milà chair
design Jaime Hayón, 2016
→ more info / p. 80

Officina table
design Ronan & Erwan Bouroullec, 2015





Traffic sofa + low table
design Konstantin Grcic, 2014

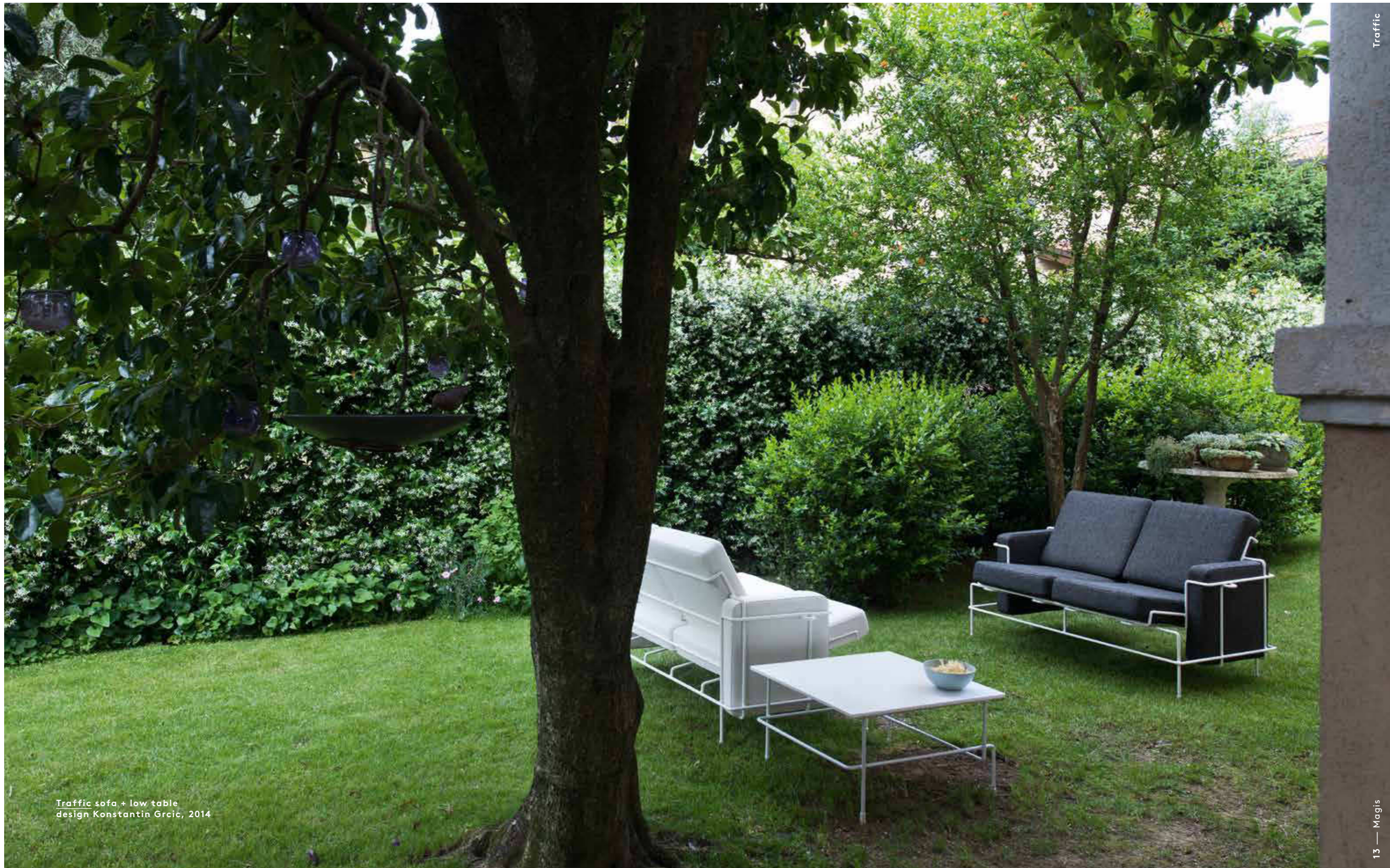



Traffic sofa + low table
design Konstantin Grcic, 2014



Substance chair
design Naoto Fukasawa, 2016
→ more info / p. 83→85

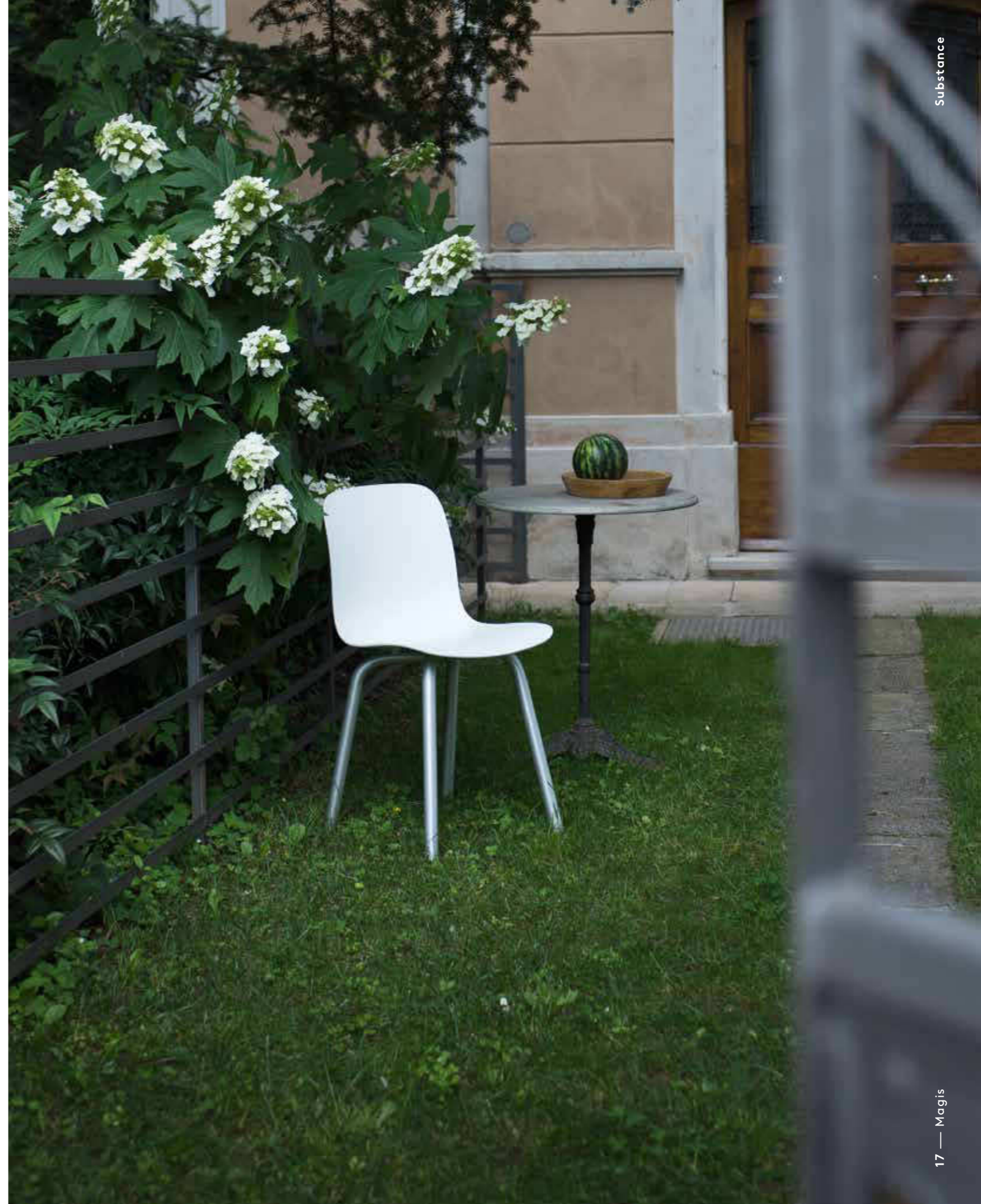



Stanley director's chair
design Philippe Starck, 2017
→ more info / p. 82

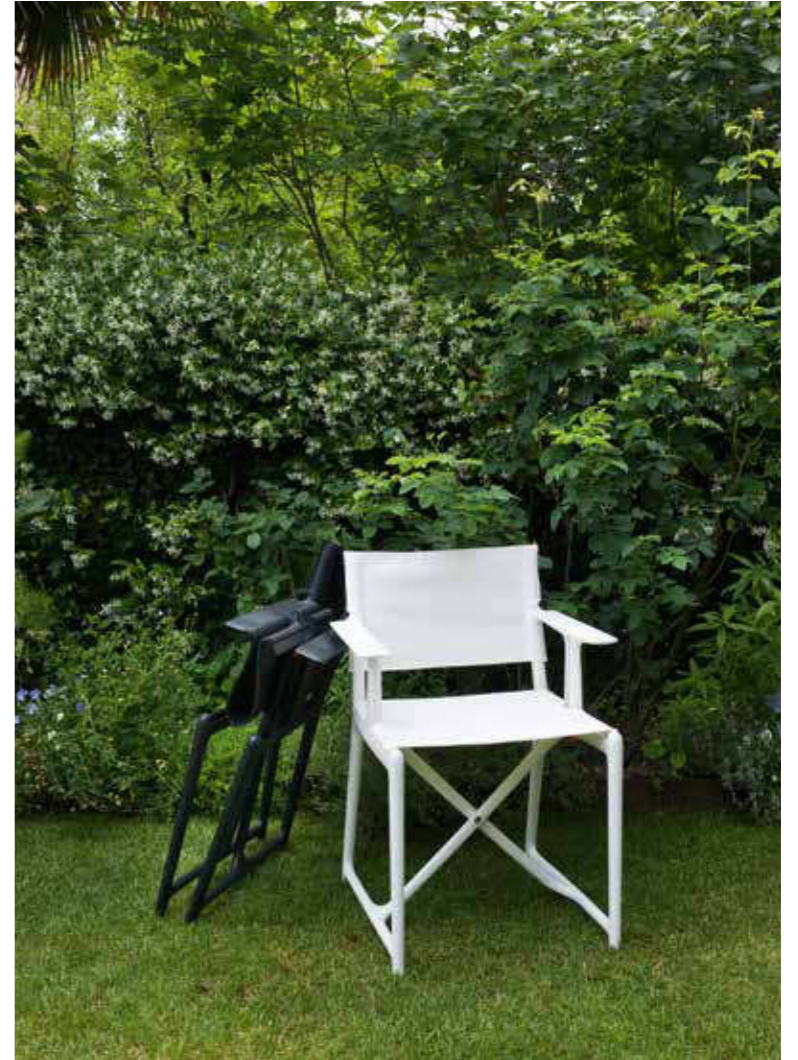



Sam Son low chair
design Konstantin Grcic, 2015
→ more info / p. 92





XZ3 table
design Magis, 1990/2003
→ more info / p. 96-97

Substance chair
design Naoto Fukasawa, 2015
→ more info / p. 83-85



Substance armchair
design Naoto Fukasawa, 2015
→ more info / p. 83→85





Substance armchair
design Naoto Fukasawa, 2015
→ more info / p. 83-85

Cuckoo - The Wild Bunch table
design Konstantin Grcic, 2015
→ more info / p. 94



Substance chair
design Naoto Fukasawa, 2017
→ more info / p. 83-85

XZ3 table
design Magis, 1990 - 2003
→ more info / p. 96-97



Substance chair
design Naoto Fukasawa, 2017
→ more info / p. 83-85

Pipe table
design Jasper Morrison, 2009





Officina tree candle holder
design Ronan & Erwan Bouroullec, 2017
→ more info / p. 105



Officina floor candle holder
design Ronan & Erwan Bouroullec, 2016
→ more info / p. 104

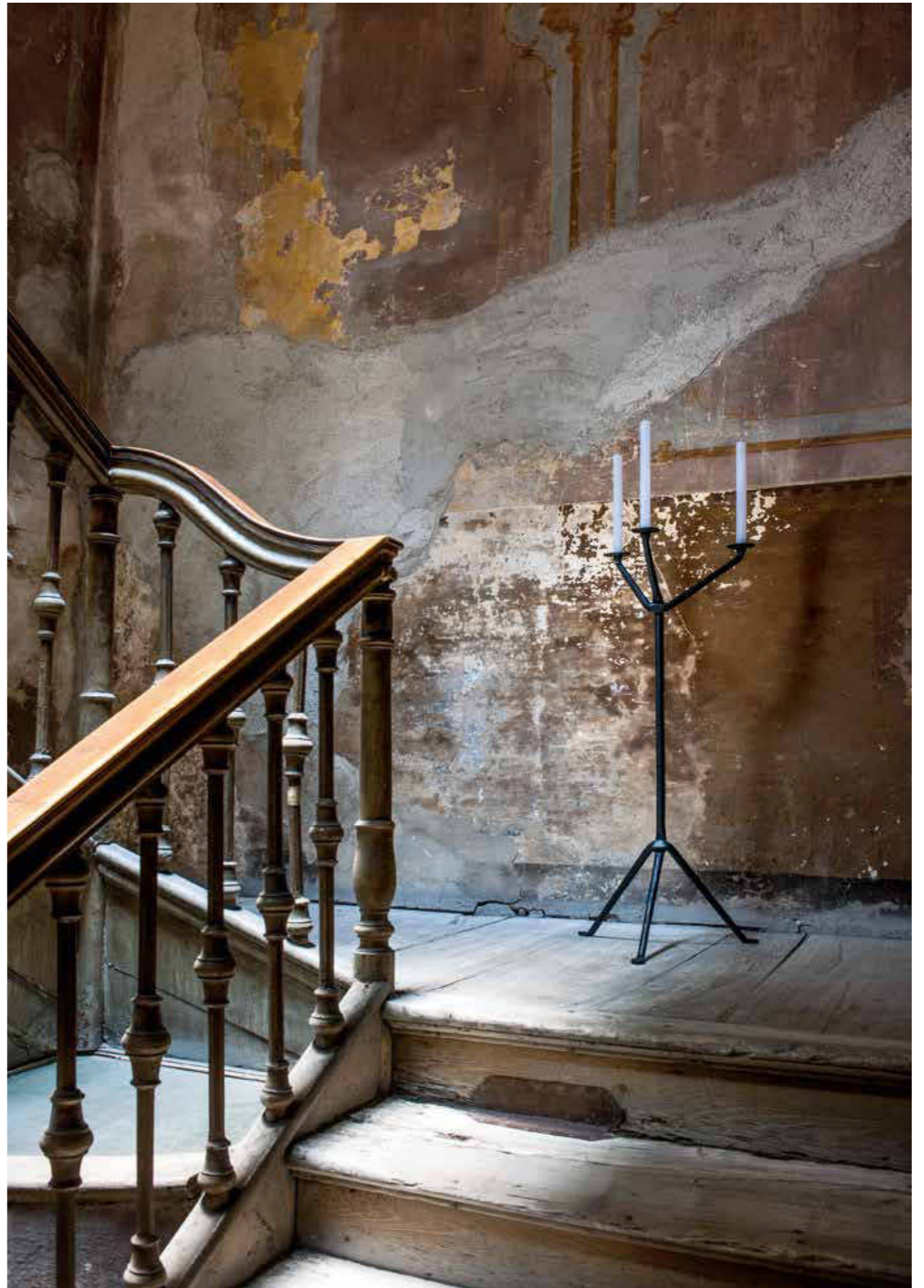



Officina floor candle holder
design Ronan & Erwan Bouroullec, 2016
→ more info / p. 104

Ettore ornament / door-stop
design Konstantin Grcic, 2016
→ more info / p. 100





Officina chair
design Ronan & Erwan Bouroullec, 2016
→ more info / p. 81

Officina table
design Ronan & Erwan Bouroullec, 2015



Officina table candlestick
design Ronan & Erwan Bouroullec, 2016
→ more info / p. 103



Officina wall coat hanger
design Ronan & Erwan Bouroullec, 2016
→ more info / p. 99

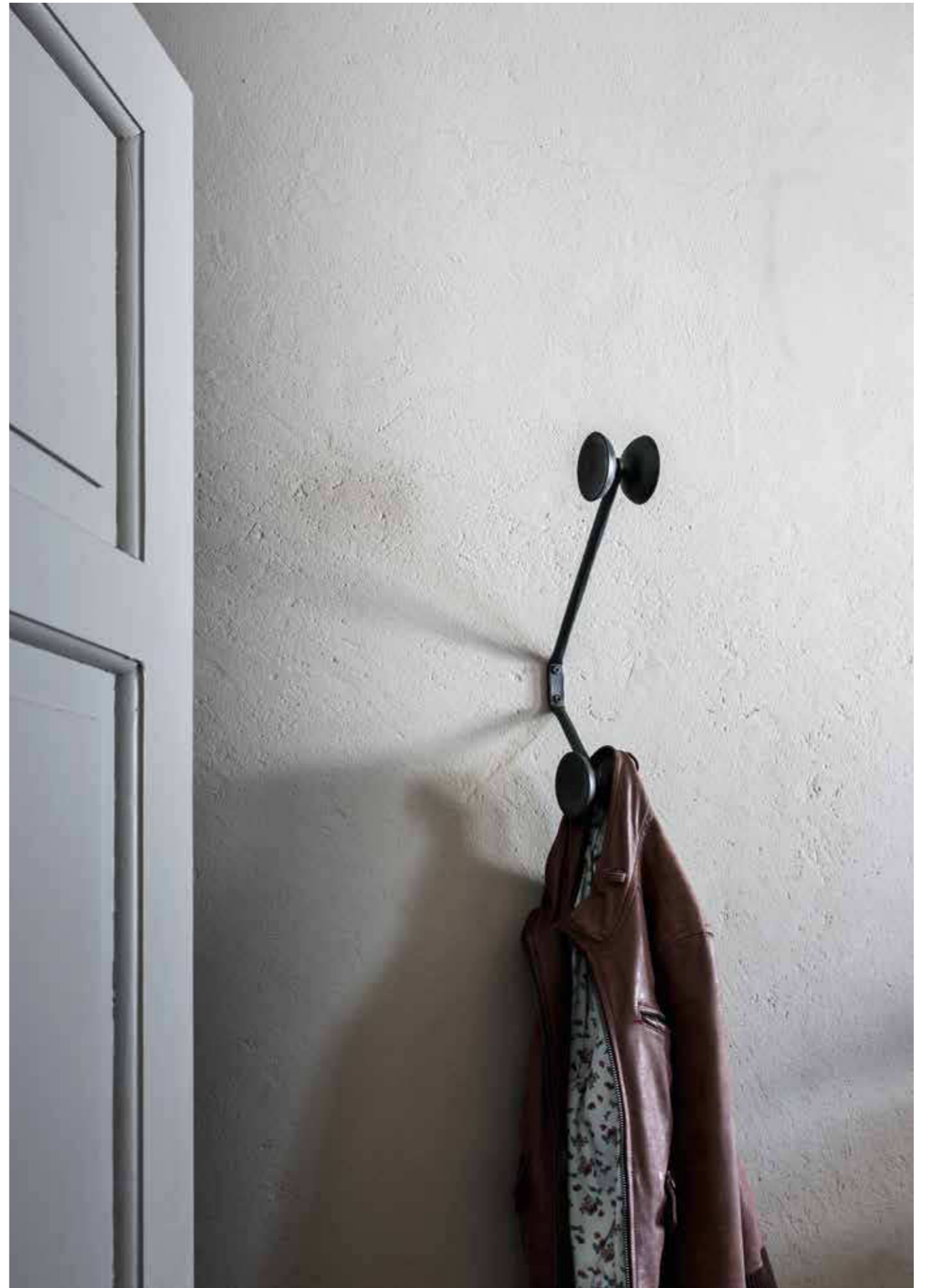

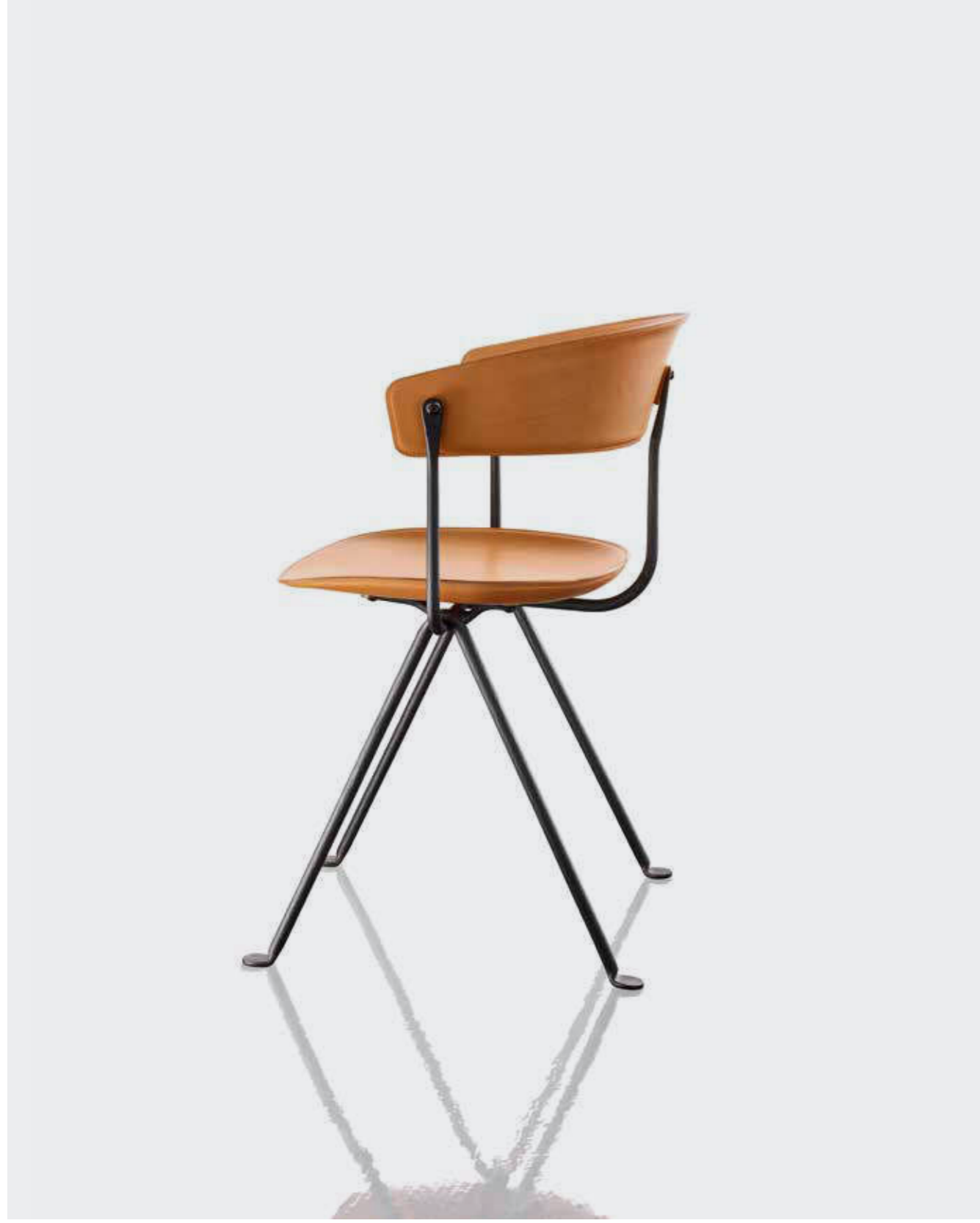



Officina coat stand
design Ronan & Erwan Bouroullec, 2016
→ more info / p. 98



Officina valet stand
design Ronan & Erwan Bouroullec, 2016
→ more info / p. 101



Officina double sided mirror
design Ronan & Erwan Bouroullec, 2016
→ more info / p. 102



Cyborg armchair
design Marcel Wanders, 2017
→ more info / p. 76





Cyborg armchair
design Marcel Wanders, 2015
→ more info / p. 77

Traffic bench
design Konstantin Grcic, 2013

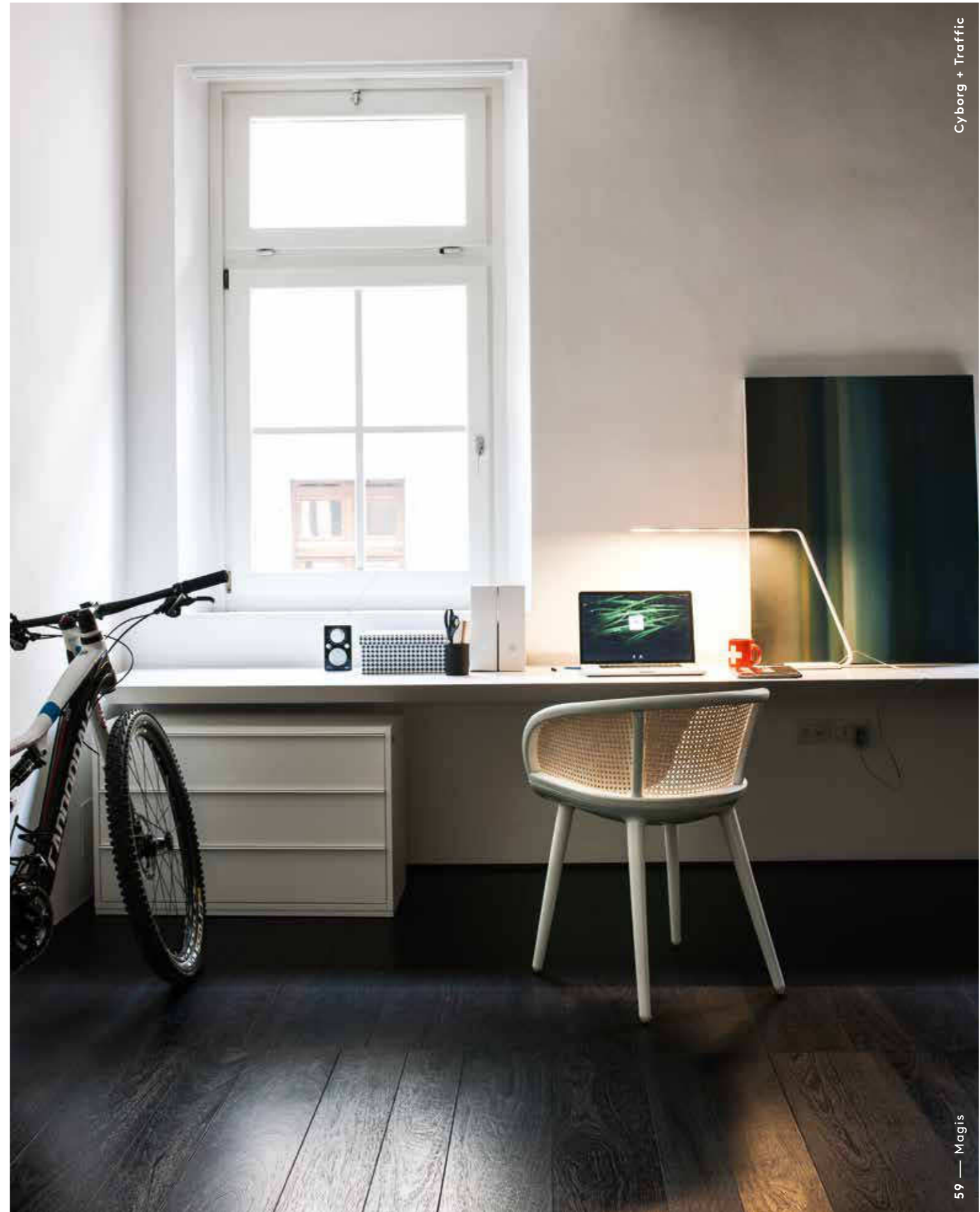

Sam Son low chair
design Konstantin Grcic, 2015
→ more info / p. 92





Officina stool
design Ronan & Erwan Bouroullec, 2016
→ more info / p. 91



Officina low table
design Ronan & Erwan Bouroullec, 2015



Troy chair
design Marcel Wanders, 2016
→ more info / p. 86-90

Traffic table
design Konstantin Grcic, 2016
→ more info / p. 95



Troy chair
design Marcel Wanders, 2016
→ more info / p. 86-90



Officina table
design Ronan & Erwan Bouroullec, 2015





Troy seating system
design Marcel Wanders, 2016
→ more info / p. 93



Chairs + Armchairs

76→78 **Cyborg**
79-80 **Milà**
81 **Officina**
82 **Stanley**
83→85 **Substance**
86→90 **Troy**

Stools

91 **Officina**

Low chairs

92 **Sam Son**

Public seating systems

93 **Troy**

Tables + Low tables

94 **Cuckoo - The Wild Bunch**
95 **Traffic**
96-97 **XZ3**

Coat stands + Coat hangers

98-99 **Officina**

Accessories

100 **Ettore**
101→105 **Officina**

106-107 **Fabrics + Leather**

Armchair

Material: frame in air-moulded polycarbonate. Back in aluminium painted in polyester powder. Suitable for outdoor use.

Sillón

Material: estructura en policarbonato moldeado por air moulding. Respaldo en aluminio barnizado poliéster. Apta para el exterior.

Petit fauteuil

Matériaux: structure en polycarbonate en air moulding. Dossier en aluminium verni en polyester. Conçu pour l'extérieur.

Sessel

Material: Gestell aus Polykarbonat hergestellt im Gaseinspritzverfahren. Rückenlehne aus Aluminium, polyesterlackiert. Auch für den Aussenbereich geeignet.

Poltroncina

Materiali: Struttura in policarbonato stampato in air-moulding. Schienale in alluminio verniciato poliester. Adatta anche per esterni.

→ image /p. 56, 57

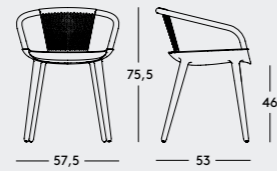

Cyborg Daisy



Frame: Glossy Black 1763 C
Back: Dark Grey "gun metal"

Frame: Glossy White 1736 C
Back: Beige "champagne"

Armchair

Material: frame in air-moulded polycarbonate. Back in painted solid ash and in woven cane.

Sillón

Material: estructura en policarbonato moldeado por air moulding. Respaldo en madera maciza de fresno barnizado y caña natural.

Petit fauteuil

Matériaux: structure en polycarbonate en air moulding. Dossier en frêne massif verni et cannée naturel.

Sessel

Material: Gestell aus Polykarbonat hergestellt im Gaseinspritzverfahren. Rückenlehne aus massiver Esche, lackiert und aus Wiener Geflecht.

Poltroncina

Materiali: struttura in policarbonato stampato in air-moulding. Schienale in massello di frassino verniciato e in paglia di Vienna naturale.

→ image /p. 58, 59

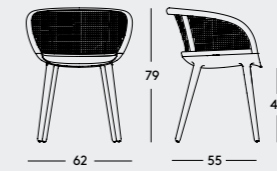

Cyborg Vienna



Frame: Glossy Black 1763 C
Back: Black
(woven cane natural)

Frame: Glossy White 1736 C
Back: White
(woven cane natural)

Armchair

Material: frame in air-moulded polycarbonate. Seat and back in polyurethane foam covered in fabric (Kvadrat "Remix 2") or in leather.

Sillón

Material: estructura en policarbonato moldeado por air moulding. Asiento y respaldo en espuma de poliuretano tapizado en tejido (Kvadrat "Remix 2") o en piel.

Petit fauteuil

Matériaux: structure en polycarbonate en air moulding. Assise et dossier en mousse de polyuréthane avec revêtement en tissu (Kvadrat "Remix 2") ou en cuir.

Sessel

Material: Gestell aus Polykarbonat hergestellt im Gaseinspritzverfahren. Sitz und Rückenlehne aus Polyurethanschaum mit Stoff- (Kvadrat "Remix 2") oder Lederbezug.

Poltroncina

Materiali: struttura in policarbonato stampato in air moulding. Sedile e schienale in poliuretano schiumato rivestito in tessuto (Kvadrat "Remix 2") o in pelle.

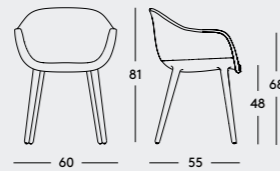

Cyborg Lady



Frame: Glossy White 1736 C
Seat + Back: Grey F-770

Frame: Glossy White 1736 C
Seat + Back: Pink F-771

Frame: Glossy White 1736 C
Seat + Back: Green F-772

Frame: Glossy White 1736 C
Seat + Back: Ocher F-773



Frame: Glossy Black 1763 C
Seat + Back: Grey F-770

Frame: Glossy Black 1763 C
Seat + Back: Pink F-771

Frame: Glossy Black 1763 C
Seat + Back: Green F-772

Frame: Glossy Black 1763 C
Seat + Back: Ocher F-773

Frame: Glossy Black 1763 C
Seat + Back: Black L-0795 leather

Stacking chair with arms

Material: polypropylene with glass fibre added. Air-moulded. Silky touch finish. Suitable for outdoor use.

Silla con brazos apilable

Material: polipropileno reforzado con fibra de vidrio en air moulding. Acabado efecto seda. Apta para el exterior.

Chaise empilable

avec accoudoirs
Matériaux: polypropylène chargé avec fibre de verre en air moulding. Finition effet soie. Conçue pour l'extérieur.

Stuhl mit Armlehnen, stapelbar

Material: Polypropylen mit Glasfaser verstärkt. Hergestellt im Gaseinspritzverfahren. Oberfläche mit "Silky-Touch" Technologie veredelt. Auch für den Aussenbereich geeignet.

Sedia impilabile

con braccioli
Materiali: polipropilene caricato di fibra di vetro, stampato in air-moulding. Finitura effetto seta. Adatta anche per esterni.

-> image /p. 05, 06-07, 10

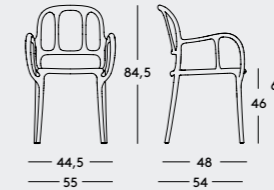

Matt colour
Red 1484 C

Matt colour
Dark Green 1556 C

Matt colour
Yellow 1666 C

Matt colour
Beige 1733 C



Matt colour
White 1738 C

Matt colour
Black 1769 C

Chair with arms

Material: polypropylene with glass fibre added. Air-moulded. Silky touch finish. Seat/back cushion in expanded polyurethane with cover in fabric (Fidivi "King L Kat" and "King L").

Silla con brazos

Material: polipropileno reforzado con fibra de vidrio en air moulding. Acabado efecto seda. Cojín asiento/respaldo de poliuretano expandido, tapizado en tejido (Fidivi "King L Kat" y "King L").

Chaise avec accoudoirs

Matériaux: polypropylène chargé avec fibre de verre en air moulding. Finition effet soie. Coussin assise/dossier en polyuréthane expansé. Revêtement en tissu (Fidivi « King L Kat » et « King L »).

Stuhl mit Armlehnen

Material: Polypropylen mit Glasfaser verstärkt. Hergestellt im Gaseinspritzverfahren. Oberfläche mit "Silky-Touch" Technologie veredelt. Sitz- und Rückenlehnekissen aus geschäumtem Polyurethan mit Stoffbezug (Fidivi „King L Kat“ und „King L“).

Sedia con braccioli

Materiali: polipropilene stampato in air-moulding. Finitura effetto seta. Cuscino sedile/schienale in poliuretano espanso, rivestito in tessuto (Fidivi "King L Kat" e "King L").

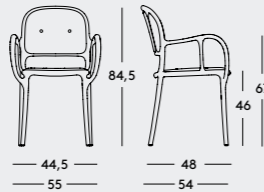

→ image /p. 08, 09, 11



Frame: Red 1484 C
Cushions: King L Kat Red F-130



Frame: Dark Green 1556 C
Cushions: King L Green F-359



Frame: Yellow 1666 C
Cushions: King L Kat Yellow F-579



Frame: Beige 1733 C
Cushions: King L Kat Beige F-459



Frame: White 1738 C
Cushions: King L Kat White F-739



Frame: Black 1769 C
Cushions: King L Black F-198

Chair

Material: frame in wrought iron, galvanized or cathodically treated and painted in polyester powder. Seat and back in standard injection-moulded polypropylene with glass fibre added (suitable for outdoor use) or in polypropylene covered in premium-grade leather.

Silla

Material: estructura de hierro forjado, zincado en caliente o tratado anti óxido y barnizado en poliéster. Asiento y respaldo en polipropileno moldeado por inyección estándar, reforzado con fibra de vidrio (apta para el exterior) o en polipropileno tapizado en cuero de grano superior.

Chaise

Matériaux: structure en fer forgé galvanisé ou traité en cathorèse et verni en polyester. Assise et dossier en polypropylène chargé avec fibre de verre moulé par injection standard (conçu pour l'extérieur) ou en polypropylène avec revêtement en cuir pleine-fleur.

Stuhl

Material: Gestell aus Schmiedeeisen, verzinkt oder rostschutzbehandelt und polyesterlackiert. Sitz und Rückenlehne aus Polypropylen mit Glasfaser verstärkt und hergestellt im Standard-Einspritzverfahren (auch für den Aussenbereich geeignet) oder aus Polypropylen mit Volllederbezug.

Poltroncina

Materiali: struttura in ferro forgiato, zincato a caldo o trattato cataforesi e verniciato poliesteri. Sedile e schienale in polipropilene stampato ad iniezione standard e caricato con fibra di vetro (adatta per esterni). Disponibile anche sedile e schienale in polipropilene rivestito in cuoio primo fiore.

→ image /p. 44, 45, 50, 51
7

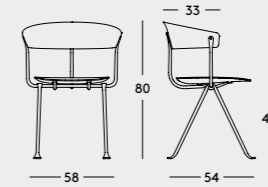

Frame: Galvanized
Seat and Back: Dark Green 1555 C



Frame: Galvanized
Seat and Back: Metallised Grey 1761 C



Frame: Galvanized
Seat and Back: Black 1763 C



Frame: Black
Seat and Back: Dark Green 1555 C



Frame: Black
Seat and Back: Metallised Grey 1761 C



Frame: Black
Seat and Back: Black 1763 C



Frame: Galvanized
Seat and Back: Natural Leather L-0090



Frame: Galvanized
Seat and Back: Black Leather L-0060



Frame: Black
Seat and Back: Natural Leather L-0090



Frame: Black
Seat and Back: Black Leather L-0060

Folding director's chair
 Material: polypropylene with glass fibre added. Seat and back in fabric (Plastitex "Thinny_New York").

Silla de director plegable
 Material: estructura de polipropileno reforzado con fibra de vidrio. Asiento y respaldo en tejido (Plastitex "Thinny_New York").

Chaise réalisateur pliante
 Matériaux: structure en polypropylène chargé avec fibre de verre. Assise et dossier en tissu (Plastitex "Thinny_New York").

Regiestuhl, klappbar
 Material: Gestell aus Polypropylen mit Glasfaser verstärkt. Sitz und Rückenlehne aus Stoff (Plastitex "Thinny_New York").

Sedia da regista pieghevole
 Materiali: struttura in polipropilene caricato di fibra di vetro. Sedile e schienale in tessuto (Plastitex "Thinny_New York").

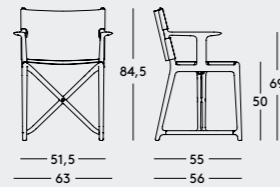

Frame: White 1735 C
 Seat + Back: White F-738

Frame: Beige 1733 C
 Seat + Back: Beige F-458

Frame: Black 1765 C
 Seat + Back: Black F-758

Chair and armchair
 Material: frame in ash plywood, natural or stained, in anodised aluminium tube or in steel tube chromed or painted. Seat in polypropylene or in polypropylene covered in fabric (Kvadrat "Sunniva") or in premium-grade leather.

Silla y sillón
 Material: estructura en multiestrato de fresno natural o barnizado, en tubo de aluminio anodizado o en tubo de acero cromado o barnizado poliéster. Asiento de polipropileno o polipropileno tapizado en tejido (Kvadrat "Sunniva") o en cuero de grano superior.

Chaise et petit fauteuil
 Matériaux: structure en frêne multiplis, naturel ou teinté, en tube d'aluminium anodisé ou en tube d'acier chromé ou verni en polyester. Assise en polypropylène ou polypropylène revêtue en tissu (Kvadrat "Sunniva") ou cuir pleine fleur.

Stuhl und Sessel
 Material: Gestell aus Eschenschichtholz, naturfarben oder lackiert, aus eloxiertem Aluminiumrohr, aus verchromtem oder polyesterlackiertem Stahlrohr. Sitz aus Polypropylen mit Stoff- (Kvadrat "Sunniva") oder Volllederbezug.

Sedia e poltroncina
 Materiali: struttura in multistrato di frassino naturale o verniciato, in tubo di alluminio anodizzato o in tubo di acciaio cromato o verniciato. Sedile in polipropilene, o polipropilene rivestito in tessuto (Kvadrat "Sunniva") o in cuoio primo fiore.

→ image / p. 17, 24, 25, 27, 28, 29, 31, 32-33, 34, 35

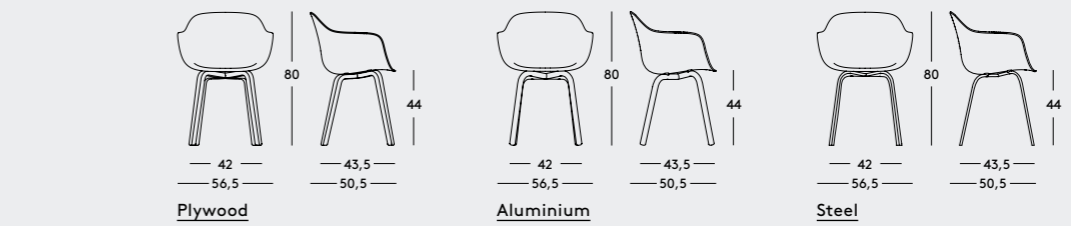
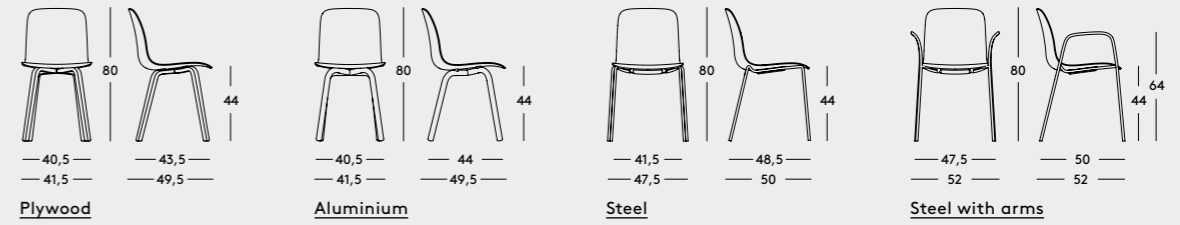

Substance Substance Substance Substance with arms



Substance armchair Substance armchair Substance armchair



Plywood / polypropylene
Frame: Natural
Seat: White 1735 C



Plywood / polypropylene
Frame: Natural
Seat: Mustard 1015 C



Plywood / polypropylene
Frame: Natural
Seat: Beige 1452 C



Plywood / polypropylene
Frame: Natural
Seat: Black 1768 C



Plywood / polypropylene
Frame: Black
Seat: Black 1768 C



Aluminium / leather
Frame: Black
Seat: black L-0060



Steel / polypropylene
Frame: Chromed
Seat: White 1735 C



Steel / polypropylene
Frame: Chromed
Seat: Mustard 1015 C



Steel / polypropylene
Frame: Chromed
Seat: Beige 1452 C



Steel / polypropylene
Frame: Chromed
Seat: Black 1768 C



Plywood / fully covered
Frame: Natural
Seat: R1 Sunniva Beige (717)



Plywood / fully covered
Frame: Natural
Seat: R2 Sunniva Pink (236)



Plywood / fully covered
Frame: Natural
Seat: R3 Sunniva Light Green (132)



Plywood / fully covered
Frame: Black
Seat: R4 Sunniva Dark Grey (1079)



Plywood / leather
Frame: Natural
Seat: Natural L-0090



Steel / polypropylene
Frame: White 5110
Seat: White 1735 C



Steel / polypropylene
Frame: White 5110
Seat: Mustard 1015 C



Steel / polypropylene
Frame: White 5110
Seat: Beige 1452 C



Steel / polypropylene
Frame: Black 5140
Seat: Mustard 1015 C



Steel / polypropylene
Frame: Black 5140
Seat: Beige 1452 C



Plywood / leather
Frame: Black
Seat: Black L-0060



Aluminium / polypropylene
Frame: Natural
Seat: White 1735 C



Aluminium / polypropylene
Frame: Natural
Seat: Mustard 1015 C



Aluminium / polypropylene
Frame: Natural
Seat: Beige 1452 C



Aluminium / polypropylene
Frame: Black
Seat: Black 1768 C



Steel / polypropylene
Frame: Black 5140
Seat: Black 1768 C



Aluminium / fully covered
Frame: Natural
Seat: R1 Sunniva Beige (717)



Aluminium / fully covered
Frame: Natural
Seat: R2 Sunniva Pink (236)



Aluminium / fully covered
Frame: Natural
Seat: R3 Sunniva Light Green (132)



Aluminium / fully covered
Frame: Black
Seat: R4 Sunniva Dark Grey (1079)



Aluminium / leather
Frame: Natural aluminium
Seat: Natural L-0090

Chair

Material: frame in steel rod (gold or copper coated) or painted in polyester powder. Seat in beech plywood, in polypropylene or in polypropylene covered in fabric (Kvadrat "Divina"). Also available with front side covered in fabric (Kvadrat "Divina", "Steelcut Trio" or "Steelcut 2") or in leather.

Silla

Material: estructura en barra de acero (color dorado o cobre) o barnizado poliéster. Asiento en multiestrato de haya, en polipropileno o en polipropileno tapizado en tejido (Kvadrat "Divina"). También con la parte anterior del asiento tapizada en tejido (Kvadrat "Divina", "Steelcut Trio" o Steelcut 2") o en piel.

Chaise

Matériaux: structure en fil acier (or ou cuivre) ou verni en polyester. Assise en hêtre multiplis, en polypropylène ou en polypropylène revêtu en tissu (Kvadrat "Divina"). Aussi disponible avec la partie antérieure de l'assise revêtue en tissu (Kvadrat "Divina", "Steelcut Trio" ou Steelcut 2") ou en cuir.

Stuhl

Material: Gestell aus Stahldraht, (kupfer-oder goldbeschicht) oder polyesterlackiert. Sitz aus Buchenschichtholz, aus Polypropylen oder aus Polypropylen mit Stoffbezug (Kvadrat "Divina"). Lieferbar auch mit Vorderseite mit Stoff- (Kvadrat "Divina", "Steelcut Trio" oder Steelcut 2") oder Lederbezug.

Sedia

Materiali: struttura in tondino di acciaio (dorato o ramato) o verniciato poliester. Sedile in multistrato di faggio, in polipropilene o in polipropilene rivestito in tessuto (Kvadrat "Divina"). Anche con fronte anteriore rivestito in tessuto (Kvadrat "Divina", "Steelcut Trio" o Steelcut 2") o in pelle.

→ image /p. 70

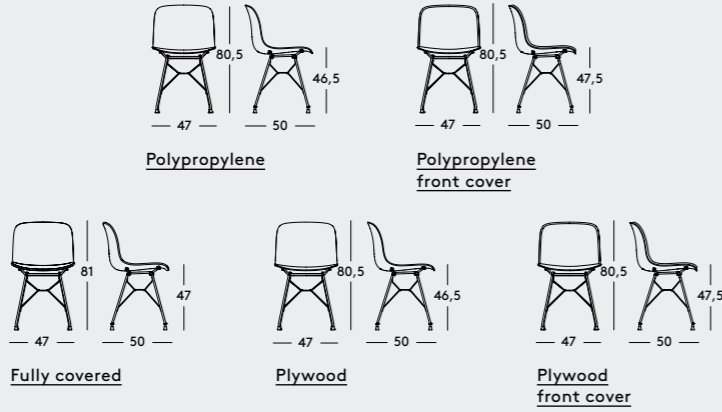

Chair

Material: legs in solid ash, natural or painted. Joining element in die-cast aluminium, sanded. Seat in beech plywood, in polypropylene or in polypropylene covered in fabric (Kvadrat "Divina"). Also available with front side covered in fabric (Kvadrat "Divina", "Steelcut Trio" or "Steelcut 2") or in leather.

Silla

Material: patas en haya maciza, natural o barnizadas. Elemento de conexión en profusión de aluminio fundido a presión, arenado. Asiento en multiestrato de haya, en polipropileno o en polipropileno tapizado en tejido (Kvadrat "Divina"). También con la parte anterior del asiento tapizada en tejido (Kvadrat "Divina", "Steelcut Trio" o Steelcut 2") o en piel.

Chaise

Matériaux: pieds en hêtre massif, naturel ou teinté. Élément de jonction en fonte d'aluminium sablé. Assise en hêtre multiplis, en polypropylène ou en polypropylène revêtu en tissu (Kvadrat "Divina"). Aussi disponible avec la partie antérieure de l'assise revêtue en tissu (Kvadrat "Divina", "Steelcut Trio" ou Steelcut 2") ou en cuir.

Stuhl

Material: Beine aus massiver Buche naturfarben oder lackiert. Verbindungselement aus Aluminium- Druckguss, sandgestrahlt. Sitz aus Buchenschichtholz, aus Polypropylen oder aus Polypropylen mit Stoffbezug (Kvadrat "Divina"). Lieferbar auch mit Vorderseite mit Stoff- (Kvadrat "Divina", "Steelcut Trio" oder Steelcut 2") oder Lederbezug.

Sedia

Materiali: gambe in massello di faggio naturale o verniciato. Elemento di connessione in pressofusione di alluminio sabbato. Sedile in multistrato di faggio, in polipropilene o in polipropilene rivestito in tessuto (Kvadrat "Divina"). Anche con fronte anteriore rivestito in tessuto (Kvadrat "Divina", "Steelcut Trio" o "Steelcut 2") o in pelle.

→ image /p. 66-67, 68, 69, 71

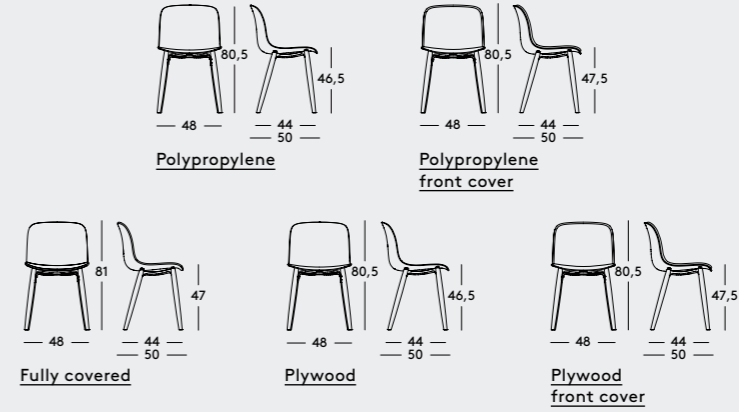



Polypropylene
Frame: Gold
Seat: Red 1483 C



Polypropylene
Frame: Gold
Seat: White 1735 C



Polypropylene
Frame: Gold
Seat: Black 1763 C



Polypropylene
Frame: Copper
Seat: Red 1483 C



Polypropylene
Frame: Copper
Seat: White 1735 C



Fully covered
Frame: White 5110
Seat: Red Mélange F-126 (531)



Fully covered
Frame: White 5110
Seat: Blue F-251 (773)



Fully covered
Frame: White 5110
Seat: Purple Mélange F-492 (581)



Fully covered
Frame: White 5110
Seat: Light Grey Mélange F-506 (120)



Fully covered
Frame: White 5110
Seat: Grey Mélange F-509 (170)



Polypropylene
Frame: Copper
Seat: Black 1763 C



Polypropylene
Frame: White 5110
Seat: White 1735 C



Polypropylene
Frame: Black 5140
Seat: Black 1763 C



Fully covered
Frame: Gold
Seat: Red Mélange F-126 (531)



Fully covered
Frame: Gold
Seat: Blue F-251 (773)



Fully covered
Frame: White 5110
Seat: Dark Grey Mélange F-512 (180)



Fully covered
Frame: Black 5140
Seat: Blue F-251 (773)



Fully covered
Frame: Black 5140
Seat: Purple Mélange F-492 (581)



Fully covered
Frame: Black 5140
Seat: Dark Grey Mélange F-512 (180)



Plywood
Frame: Gold
Seat: Natural Beech 7010



Fully covered
Frame: Gold
Seat: Purple Mélange F-492 (581)



Fully covered
Frame: Gold
Seat: Light Grey Mélange F-506 (120)



Fully covered
Frame: Gold
Seat: Grey Mélange F-509 (170)



Fully covered
Frame: Gold
Seat: Dark Grey Mélange F-512 (180)



Fully covered
Frame: Copper
Seat: Red Mélange F-126 (531)



Plywood
Frame: Gold
Seat: Bleached Beech 7025



Plywood
Frame: Gold
Seat: Black Beech 7065



Plywood
Frame: Copper
Seat: Natural Beech 7010



Plywood
Frame: Copper
Seat: Bleached Beech 7025



Plywood
Frame: Copper
Seat: Black Beech 7065



Fully covered
Frame: Copper
Seat: Blue F-251 (773)



Fully covered
Frame: Copper
Seat: Purple Mélange F-492 (581)



Fully covered
Frame: Copper
Seat: Light Grey Mélange F-506 (120)



Fully covered
Frame: Copper
Seat: Grey Mélange F-509 (170)



Fully covered
Frame: Copper
Seat: Dark Grey Mélange F-512 (180)



Plywood
Frame: White 5105
Seat: Bleached Beech 7025



Plywood
Frame: Black 5140
Seat: Beech Stained Black 7065



Polypropylene
Frame: Natural Beech 7010
Seat: Red 1483 C



Polypropylene
Frame: Natural Beech 7010
Seat: White 1735 C



Polypropylene
Frame: Natural Beech 7010
Seat: Black 1763 C

Troy — design Marcel Wanders



Polypropylene
Frame: Black Beech 7065
Seat: Black 1763 C



Fully covered
Frame: Natural Beech 7010
Seat: Red Mélange F-126 (531)



Fully covered
Frame: Natural Beech 7010
Seat: Blue F-251 (773)



Fully covered
Frame: Natural Beech 7010
Seat: Purple Mélange F-492 (581)



Fully covered
Frame: Natural Beech 7010
Seat: Light Grey Mélange F-506 (120)



Fully covered
Frame: Natural Beech 7010
Seat: Grey Mélange F-509 (170)



Fully covered
Frame: Natural Beech 7010
Seat: Dark Grey Mélange F-512 (180)



Fully covered
Frame: Black Beech 7065
Seat: Blue F-251 (773)



Fully covered
Frame: Black Beech 7065
Seat: Purple Mélange F-492 (581)



Fully covered
Frame: Black Beech 7065
Seat: Dark Grey Mélange F-512 (180)



Plywood
Frame: Natural Beech 7010
Seat: Natural Beech 7010



Plywood
Frame: Natural Beech 7010
Seat: Bleached Beech 7025



Plywood
Frame: Natural Beech 7010
Seat: Black Beech 7065



Plywood
Seat: Black Beech 7065
Seat: Beech Stained Black 7065

Officina — design Ronan & Erwan Bouroullec, 2016

Stools

Material: frame in wrought iron, galvanized or cathodically treated and painted in polyester powder. Seat in standard injection-moulded polypropylene with glass fibre added (suitable for outdoor use) or in polypropylene covered in premium-grade leather.

Taburetes

Material: estructura de hierro forjado, zincado en caliente o tratado anti óxido y barnizado en poliéster. Asiento en polipropileno moldeado por inyección estándar, reforzado con fibra de vidrio (apta para el exterior) o en polipropileno tapizado en cuero de grano superior.

Tabourets

Matériaux: structure en fer forgé galvanisé ou traité en cataphorèse et verni en polyester. Assise en polypropylène chargé avec fibre de verre moulé par injection standard (conçu pour l'extérieur) ou en polypropylène avec revêtement en cuir pleine-fleur.

Stühle

Material: Gestell aus Schmiedeeisen, verzinkt oder rostschutzbehandelt und polyesterlackiert. Sitz aus Polypropylen mit Glasfaser verstärkt und hergestellt im Standard-Einspritzverfahren (auch für den Aussenbereich geeignet) oder aus Polypropylen mit Volllederbezug.

Sgabelli

Materiali: struttura in ferro forgiato, zincato a caldo o trattato cataforesi e verniciato poliesteri. Sedile in polipropilene stampato ad iniezione standard e caricato con fibra di vetro (adatto per esterni). Disponibile anche in polipropilene rivestito in cuoio primo fiore.

→ image /p. 62, 63

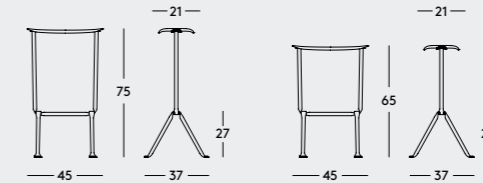

Frame: Galvanized
Seat: Dark Green 1555 C



Frame: Galvanized
Seat: Metallised Grey 1761 C



Frame: Galvanized
Seat: Black 1763 C



Frame: Black
Seat: Dark Green 1555 C



Frame: Black
Seat: Metallised Grey 1761 C



Frame: Black
Seat: Black 1763 C



Frame: Galvanized
Seat: Natural Leather L-0090



Frame: Galvanized
Seat: Black Leather L-0060



Frame: Black
Seat: Natural Leather L-0090



Frame: Black
Seat: Black Leather L-0060

Low chair

Material: rotational-moulded polyethylene. Suitable for outdoor use.

Butaca

Material: polietileno por moldeo rotacional. Apta para el exterior.

Fauteuil

Matériaux: polyéthylène moulé par rotation. Conçu pour l'extérieur.

Sessel

Material: Polyäthylen. Hergestellt im Rotationsverfahren. Auch für den Aussenbereich geeignet.

Poltroncina bassa

Materiali: polietilene in rotational moulding. Adatta anche per esterni.

→ image /p. 23, 61

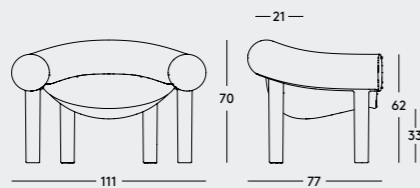

Matt colour
Red 1004 C

Matt colour
Curry 1014 C

Matt colour
Grey Anthracite 1429 C

Matt colour
White 1735 C

Seating system on bar

Frame and small table in natural solid beech. Seat in beech plywood, in polypropylene or in polypropylene covered in fabric (Kvadrat Divina). All the models are available with front side covered in fabric (Kvadrat Divina, Steelcut Trio, Steelcut 2) or in leather.

Sistema de asiento sobre barra

Estructura y mesita en madera maciza de haya natural. Asiento en multiestrato de haya, en polipropileno o en polipropileno tapizado en tejido (Kvadrat Divina). Todas las versiones están disponibles con la parte anterior del asiento tapizada en tejido (Kvadrat Divina, Steelcut Trio, Steelcut 2) o en piel.

Système d'assises sur poutre

Structure et petit table en hêtre massif. Assise en hêtre multiplis, en polypropylène ou en polypropylène revêtu en tissu (Kvadrat Divina). Tous les modèles sont disponibles avec la partie antérieure de l'assise revêtue en tissu (Kvadrat Divina, Steelcut Trio, Steelcut 2) ou en cuir.

Sitzsystem auf Schiene

Gestell und kleiner Tisch aus massiver Buche. Sitz aus Buchenschichtholz, aus Polypropylen oder aus Polykarbonat mit Stoffbezug (Kvadrat Divina). Alle Ausführungen sind mit Vorderseite mit Stoff- (Kvadrat Divina, Steelcut Trio, Steelcut 2) oder Lederbezug lieferbar.

Sistema di sedute su barra

Struttura e tavolino in massello di faggio naturale. Sedile in multistrato di faggio, in polipropilene o in polipropilene rivestito in tessuto (Kvadrat Divina). Tutti i modelli sono disponibili con fronte anteriore rivestito in tessuto (Kvadrat Divina, Steelcut Trio, Steelcut 2) o pelle.

→ image /p. 72-73

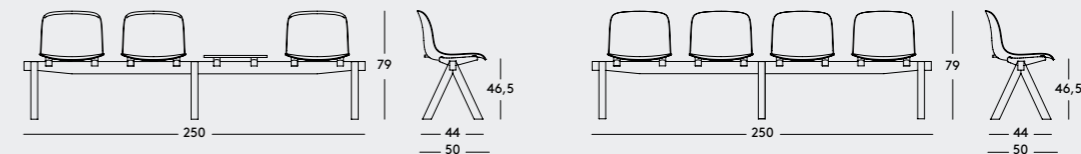

Exemples of compositions



Please see on pages 88→90 for the different seat colours/versions

Table

Material: frame in solid beech, natural or stained. Joint in polypropylene with glass fibre added. Top in painted MDF or in HPL.

Mesas

Material: estructura en madera maciza de haya natural o barnizado. Junta en polipropileno reforzado con fibra de vidrio. Tablero de MDF barnizado o de HPL.

Tables

Matériaux: structure en hêtre massif naturel ou verni. Joint en polypropylène chargé avec fibre de verre. Plateau en MDF verni ou en HPL.

Tisch

Material: Gestell aus massiver Buche naturfarben oder lackiert. Verbindungselement aus Polypropylen mit Glasfaser verstärkt. Tischplatte aus MDF lackiert oder aus HPL.

Tavolo

Materiale: struttura in massello di faggio naturale o verniciato. Giunto in polipropilene caricato di fibra di vetro. Piano in MDF verniciato o in HPL.

→ image /p. 28, 29

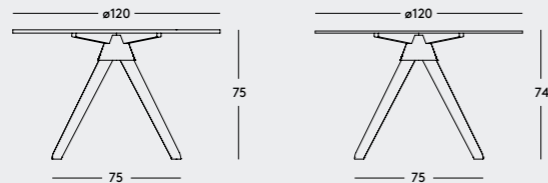

Frame: Natural Beech
Joint: White 1735 C
Top: White 8500



Frame: Natural Beech
Joint: Black 1754 C
Top: Black 8510



Frame: Beech painted Black
Joint: Black 1754 C
Top: Black 8510

Table

Pair of trestles.
Material: frame in steel rod, painted in polyester powder. Top in painted MDF.

Mesa

Par de caballetes.
Material: estructura en barra de acero barnizado poliéster. Tablero de MDF barnizado.

Table

Paire de treteaux.
Matériaux: structure en fil d'acier verni en polyester. Plateau en MDF verni.

Tisch

Böcke (paar).
Material: Gestell aus polysterlackiertem Stahldraht. Tischplatte aus lackiertem MDF.

Tavolo

Coppia di cavalletti.
Materiali: struttura in tondino di acciaio verniciato poliester. Piano in MDF verniciato.

→ image /p. 66-67

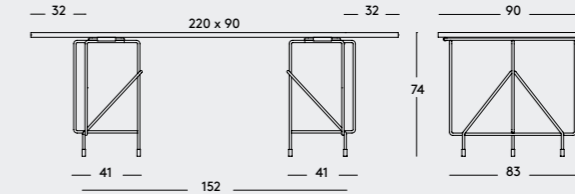

Frame: White 5108
Top: White 8500



Frame: Black 5140
Top: Black 8510

Tables

Material: frame in steel rod chromed (gold and copper coated also available) or painted in epoxy resin. Top in Carrara marble or in American walnut.

Mesas

Material: estructura en tubo redondo de acero cromado (también disponible en color dorado y cobre) o barnizado epoxi. Tablero en mármol de Carrara o en nogal americano.

Tables

Matériaux: structure en fil d'acier chromé (aussi disponible or ou cuivre) ou verni en résine époxy. Plateau en marbre de Carrare ou en noyer américain.

Tische

Material: Gestell aus Stahldraht, verchromt (auch kupfer-oder goldbeschichtet lieferbar) oder epoxylackiert. Tischplatte aus Carrara Marmor oder aus amerikanischem Walnus.

Tavoli

Materiali: struttura in tondino di acciaio cromato (disponibile anche dorato o ramato) o verniciato in resina epossidica. Piano in marmo di Carrara o in noce americano.

→ image /p. 24, 25, 31

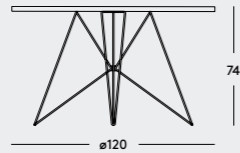

Frame: Chromed
Top: Carrara Marble White

Frame: White 5108
Top: Carrara Marble White

Frame: Black 5140
Top: Carrara Marble White

Frame: Gold
Top: Carrara Marble White

Frame: Copper
Top: Carrara Marble White



Frame: Chromed
Top: American Walnut

Frame: White 5108
Top: American Walnut

Frame: Black 5140
Top: American Walnut

Frame: Gold
Top: American Walnut

Frame: Copper
Top: American Walnut

Coat stand
 Material: frame in wrought iron, galvanized or painted in polyester powder. Hooks in rubber.

Perchero
 Material: estructura de hierro forjado, zincado en caliente o barnizado en poliéster. Ganchos de goma.

Porte-manteaux
 Matériaux: structure en fer forgé galvanisé ou verni en polyester. Crochets en caoutchouc.

Kleiderständer
 Material: Gestell aus Schmiedeeisen, verzinkt oder polyesterlackiert. Haken aus Kautschuk.

Appendiabiti
 Materiale: struttura in ferro forgiato zincato a caldo o verniciato poliester. Ganci in gomma.

→ image /p. 52-53

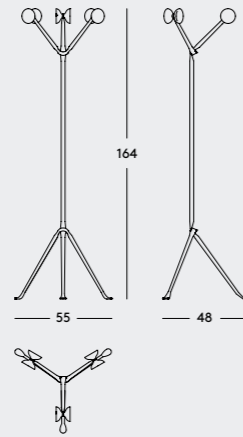

Frame: Galvanized
 Hooks: Black 1770 C

Frame: Galvanized
 Hooks: Light Grey 1771 C

Frame: Galvanized
 Hooks: Light Green 1772 C

Frame: Black
 Hooks: Black 1770 C

Frame: Black
 Hooks: Light Grey 1771 C

Frame: Black
 Hooks: Light Green 1772 C

Wall coat hanger
 Material: frame in wrought iron painted in polyester powder. Hooks in rubber.

Colgador de pared
 Material: estructura de hierro forjado barnizado en poliéster. Ganchos de goma.

Porte-manteaux mural
 Matériaux: structure en fer forgé verni en polyester. Crochets en caoutchouc.

Wandgarderobe
 Material: Gestell aus Schmiedeeisen polyesterlackiert. Haken aus Kautschuk.

Appendiabiti a muro
 Materiale: struttura in ferro forgiato verniciato poliester. Ganci in gomma.

→ image /p. 48, 49

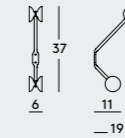

Frame: Black
 Hooks: Black 1170 C

Frame: Black
 Hooks: Light Grey 1771 C

Frame: Black
 Hooks: Light Green 1772 C

Ornament / door-stop
Material: cast-iron painted in polyester powder.

Ornamento / sujetapuertas
Material: fundición de hierro barnizado poliéster.

Ornement / butoir
Matériaux: fonte verni en polyester.

Ornament / Türstopper
Material: Gusseisen, polyesterlackiert.

Soprammobile / fermaporte
Materiale: fusione di ghisa verniciata poliester.

→ image / p. 43

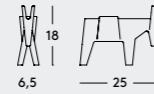

Finish: Black

Valet stand
Material: frame in wrought iron painted in polyester powder. Coat hanger and tray in rubber.

Galan de noche
Material: estructura de hierro forjado barnizado en poliéster. Percha y guardaobjetos de goma.

Valet de nuit
Matériaux: structure en fer forgé verni en polyester. Porte-manteaux et bassin en caoutchouc.

Herrendiener
Material: Gestell aus Schmiedeeisen polyesterlackiert. Kleiderhaken und Ablagefach aus Kautschuk.

Servomuto
Materiale: struttura in ferro forgiato verniciato poliester. Appendiabiti e vaschetta in gomma.

→ image / p. 54

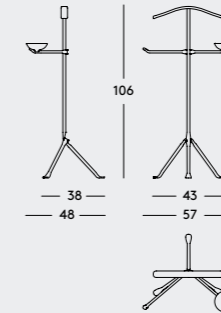

Coat hanger and tray: Black 1770 C

Double sided floor mirror with adjustable inclination
Material: frame in wrought iron painted in polyester powder. Mirror with protective back film.

Espejo de pie bifronte con inclinación ajustable
Material: estructura de hierro forjado barnizado en poliéster. Cristal con lámina adhesiva de plástico posterior.

Miroir de plancher bifrontal avec inclinaison réglable
Matériaux: structure en fer forgé verni en polyester. Miroir avec pellicule plastique de protection sur dos.

Doppelseitiges Bodenspiegel, neigungsverstellbar
Material: Gestell aus Schmiedeeisen polyesterlackiert. Spiegelglas mit Sicherheitsfolie auf der Rückseite.

Specchio bifacciale da terra inclinabile
Materiale: struttura in ferro forgiato verniciato poliester. Vetro retropellicolato.

→ image /p. 55

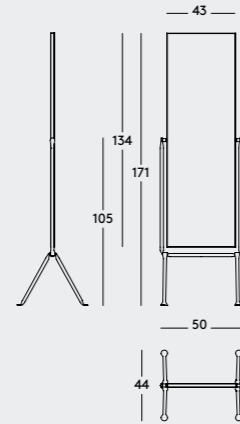

Frame: Black

Table candlesticks
Material: wrought iron painted in polyester powder.

Candelabros de mesa
Material: hierro forjado barnizado poliéster.

Chandeliers de table
Matériaux: fer forgé verni en polyester.

Tisch Leuchter
Material: Schmiedeeisen polyesterlackiert.

Candelabri da tavolo
Materiale: ferro forgiato verniciato poliester.

→ image /p. 47

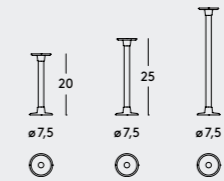

Finish: Black

Finish: Black

Finish: Black

Floor candle holders
(1, 3, 6 arms)

Material: wrought iron, cataphoretically treated and painted in polyester powder. Suitable for outdoor use.

Candelabros para suelo
(1, 3, 6 brazos)

Material: hierro forjado, tratado anti óxido y barnizado poliéster. Aptos para el exterior.

Candélabres
(1, 3, 6 branches)

Matériaux: fer forgé traité en cataphorèse et verni en polyester. Conçue pour l'extérieur.

Kerzen Armleuchter
(1, 3, 6 Arme)

Material: Schmiedeeisen, rostschutzbehandelt und polyesterlackiert. Auch für den Aussenbereich geeignet.

Candelabri da terra
(1, 3, 6 bracci)

Materiale: ferro forgiato trattato cataforesi e verniciato poliester. Adatti anche per esterni

→ image /p. 39, 40, 41, 45

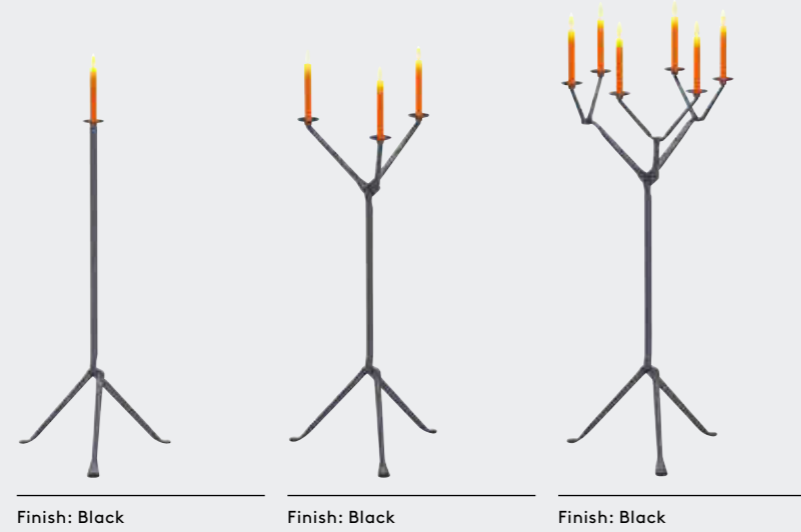
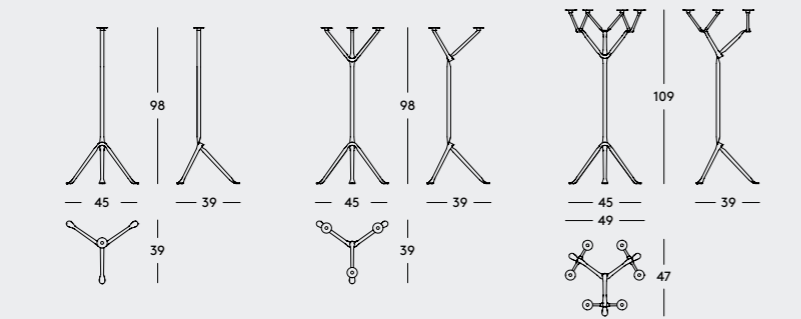

Finish: Black

Finish: Black

Finish: Black

Tree candle holder
(15 arms)

Material: wrought iron, galvanized or cataphoretically-treated and painted in polyester powder. Suitable for outdoor use.

Candelabro ad árbol
(15 brazos)

Material: hierro forjado, zincado en caliente o tratado con cataforesis y barnizado en poliéster. Apto para el exterior.

Arbre candélabre
(15 branches)

Matériaux: fer forgé galvanisé ou traité en cataphorèse et verni en polyester. Conçu pour l'extérieur.

Armleuchter Baum
(15 Arme)

Material: Schmiedeeisen, verzinkt oder rostschutzbehandelt und polyesterlackiert. Auch für den Aussenbereich geeignet.

Candelabro ad albero
(15 bracci)

Materiale: ferro forgiato zincato a caldo o trattato cataforesi e verniciato poliester. Adatto anche per esterni.

→ image /p. 37

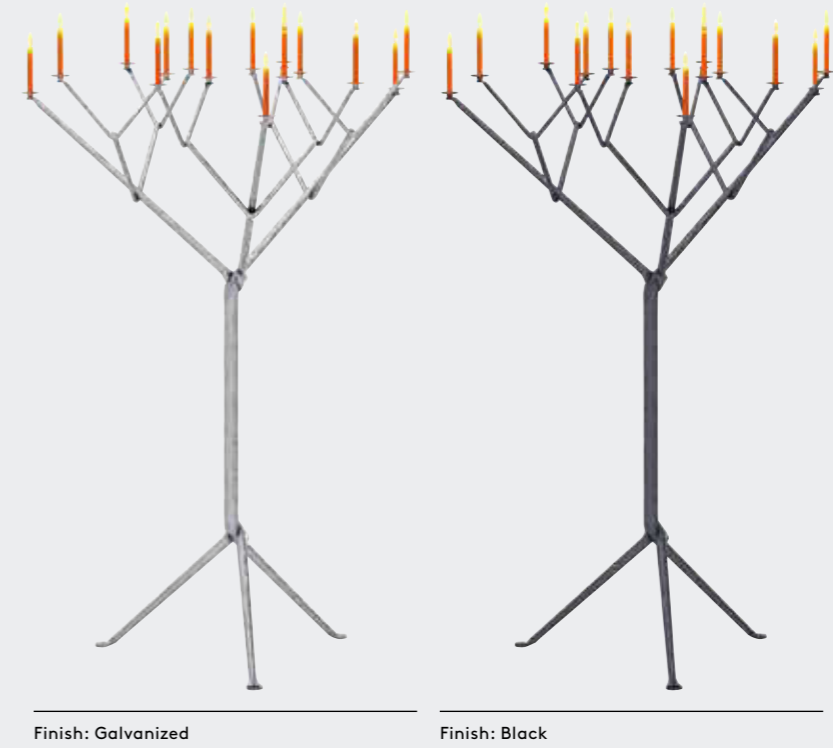
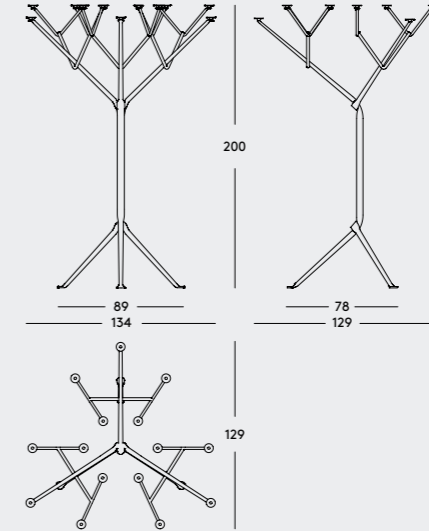

Finish: Galvanized

Finish: Black

Fabrics + Leather

Cyborg Lady

Kvadrat Remix 2
→



F-770 Grey (143)



F-771 Pink (612)

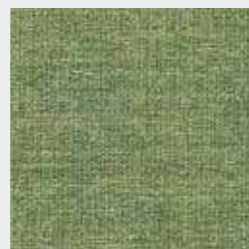

F-772 Green (933)



F-773 Ocher (433)

Cyborg Lady

Leather
→



L-0795 Black
Magis Winter

Milà

→



F-130 King L Kat Red



F-198 King L Black

Troy

Fully covered
→

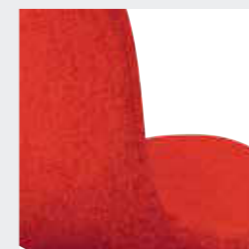

F-126 Red Mélange
(531) Divina Mélange



F-251 Blue (773)
Divina MD

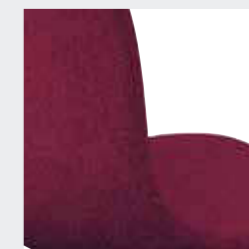

F-492 Purple Mélange
(581) Divina Mélange



F-506 Light Grey
Mélange (120) Divina
Mélange

Troy

Front cover
→



F-509 Grey Mélange
(170) Divina Mélange



F-512 Dark Grey
Mélange (180) Divina
Mélange



F-095 Pink (613)
Divina MD



F-224 Light Blue (813)
Divina MD

Officina

Leather
→

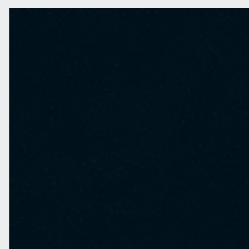

L-0060 Black



L-0090 Natural

Stanley

Plastitex
Thinny New York
→

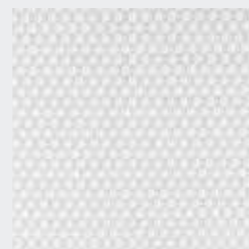

F-738 White

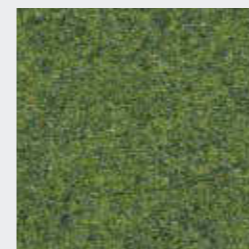

F-356 Green (943)
Divina MD

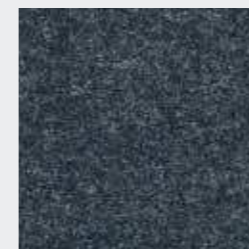

F-512 Dark Grey
Mélange (180) Divina
Mélange

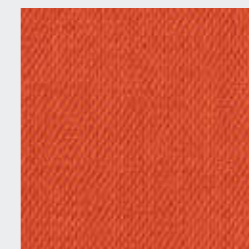

F-088 Orange (533)
Steelcut Trio

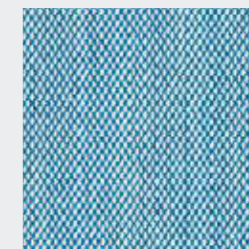

F-225 Light Blue
(733) Steelcut Trio

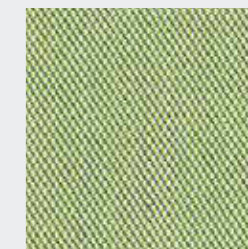

F-357 Green (933)
Steelcut Trio

Substance

Kvadrat Sunniva
→

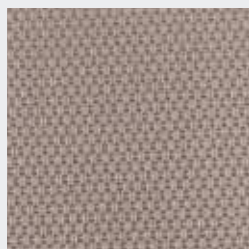

F-458 Beige



F-758 Black



R3 Light Green (132)



R2 Pink (236)



F-578 Yellow (453)
Steelcut Trio

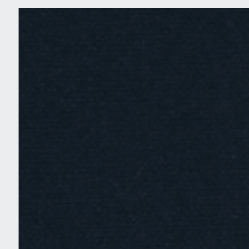

F-767 Black (190)
Steelcut 2

Troy

Front cover
Leather
→



L-0795 Black
Magis Winter

Fabrics + Leather

Substance

Leather
→



R1 Beige (717)



R4 Dark Grey (1079)

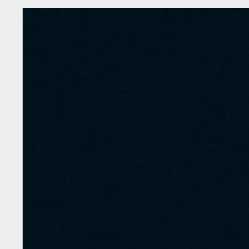

L-0060 Black

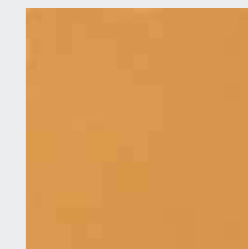

L-0090 Natural

The Kvadrat colour numbers are indicated in brackets

All rights reserved.
No part of this publication
may be reproduced, stored
in a retrieval system
or transmitted, in any form
or by any means, electronic,
mechanical, photocopyng,
recording or otherwise,
without the prior permission
of Magis Spa.
Magis reserves the right to
introduce any changes
to its own models, without
prior notice.

The printing ink cannot exactly
reproduce the colours.
For higher accuracy we suggest
inspecting the colour samples.

Thanks to
La Subida
Pratic

Graphic design: Designwork
Location photos:
ContrattiCompany
pag 05, 06-07, 08, 09, 12-13, 14, 15,
17, 18, 19, 23, 24, 25, 27, 28, 29, 37, 39,
40, 41, 43, 44, 45, 47, 48, 49, 52-53,
54, 55, 58, 59, 61, 62, 63, 65, 66-67,
68, 69
Alessandro Paderni
pag 31, 32-33, 56, 57, 72-73
Styling:
Doris Andreutti, Vanda Gemino
Still life photos: Tom Vack
Post producer: Studio Dilux

Colour separation: Lucegroup
Printed in Italy by OGM, Padova

@Magis Spa 2017

Magis Spa
via Triestina, Accesso E
Z.I. Ponte Tezze
30020 Torre di Mosto
Ve - Italia
T +39 0421 319600
F +39 0421 319700
info@magisdesign.com
magisdesign.com



