

## TILLBEHÖR/ACCESSORIES

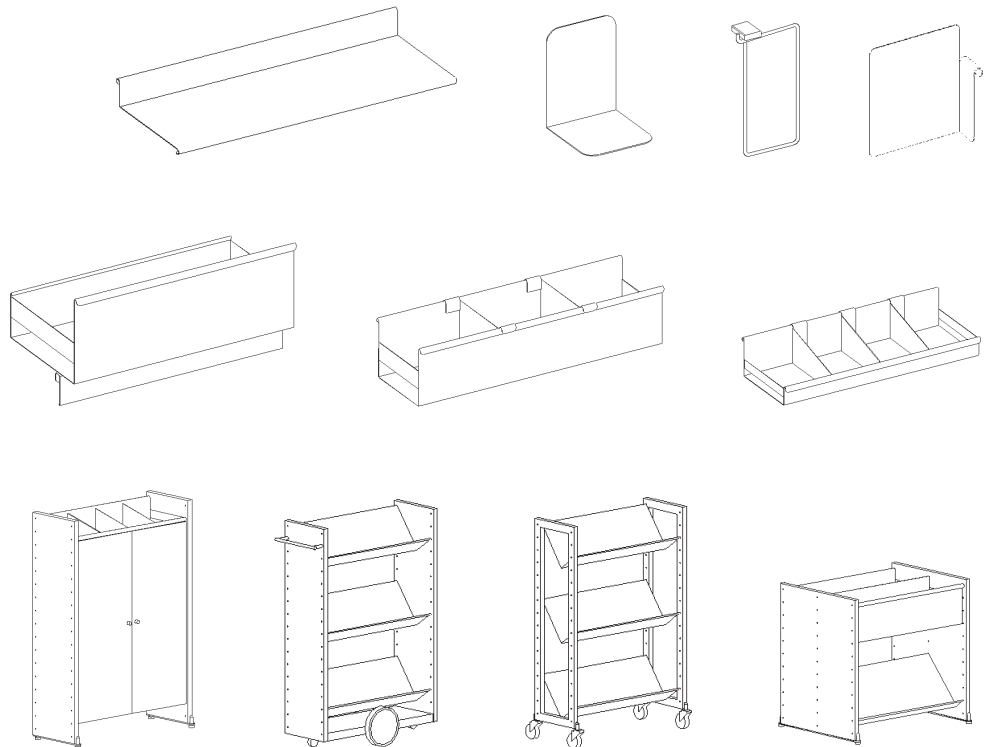

### LITTBUS TILLBEHÖR:

- TILLBEHÖR - till gavelldjup 290, 374 och 542 mm
- BOKTRÅG - start och plus
- CD/DVD/VIDEO - BOXAR - start och plus
- LÄSPLATSER - start och plus
- STUDIEBORD - start och plus
- KARTSKÅP
- POSTSKÅP
- FRÅGETERMINAL
- BOKINKAST
- DISK
- MODULER
- BELYSNING

Foto på tillbehör, se sidorna 47-51 och 66-69.

### LITTBUS ACCESSORIES:

- ACCESSORIES - to end panels 290, 374 and 542 mm
- BOOK BOXES - start and plus
- CD/DVD/VIDEO - BOXES - start and plus
- READING TABLES - start and plus
- STUDIE TABLES - start and plus
- MAP CABINETT
- POST CABINETT
- PC TERMINAL TABLE
- BOOK RETURN
- COUNTER
- MODULES
- LIGHTNING FIXTURES

Accessories images see pages 47-51 and 66-69.

## TILLBEHÖR GAVLAR 290 ACCESSORIES END PANELS 290

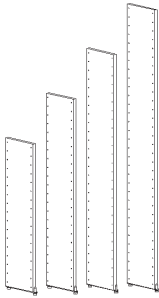
TRÄ/WOOD	BESKRIVNING/DESCRIPTION		
	Mått/Dimensions	Material	Art.nr/Art no
	290x1084	AL/ALDER	G 1210-A1
		BJÖRK/BIRCH	G 1211-B1
	290x1404	AL/ALDER	G 1310-A1
		BJÖRK/BIRCH	G 1311-B1
	290x1724	AL/ALDER	G 1510-A1
		AL SKARV/JOINT ALDER	G 1510-B1
		BJÖRK/BIRCH	G 1511-B1
	290x2044	AL/ALDER	G 1710-A1
		AL SKARV/JOINT ALDER	G 1710-B1
		BJÖRK/BIRCH	G 1711-B1

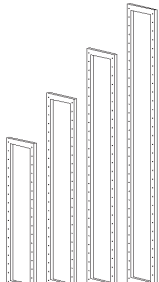
STÅL/STEEL	BESKRIVNING/DESCRIPTION		
	Mått/Dimensions	Material	Art.nr/Art.no
	290x1084	STÅL/STEEL	G 1210-S
	290x1404	STÅL/STEEL	G 1310-S
	290x1724	STÅL/STEEL	G 1510-S
	290x2044	STÅL/STEEL	G 1710-S

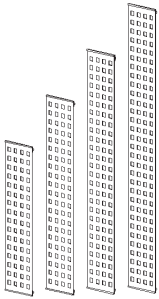
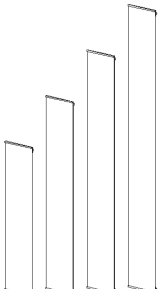
GAVELTÄCKNING/COVERING	BESKRIVNING/DESCRIPTION		
	Mått/Dimensions	Material	Art.nr/Art.no
	290x1084	PERFORERAD PLÅT/ PERFORATED STEEL	GF 1210-SP
	290x1404	PERFORERAD PLÅT/ PERFORATED STEEL	GF 1310-SP
	290x1724	PERFORERAD PLÅT/ PERFORATED STEEL	GF 1510-SP
	290x2044	PERFORERAD PLÅT/ PERFORATED STEEL	GF 1710-SP
	290x1084	FROSTAT GLAS/FROSTED GLASS	GF 1210-G2
	290x1404	FROSTAT GLAS/FROSTED GLASS	GF 1310-G2
	290x1724	FROSTAT GLAS/FROSTED GLASS	GF 1510-G2
	290x2044	FROSTAT GLAS/FROSTED GLASS	GF 1710-G2

## TILLBEHÖR 290 ACCESSORIES 290

HYLLPLAN/SHELF	BESKRIVNING/DESCRIPTION		
	Djup/Depth	Bredd/Width	Art.nr/Art.no
	252/64	C/C 516	HP 0110
		C/C 725	HP 1110
		C/C 900	HP 3110
	252/128	C/C 516	HP 0130
		C/C 725	HP 1130
		C/C 900	HP 3130
	192/304	C/C 725	HP 1170
		C/C 900	HP 3170
	310/64	C/C 516	HP 0140
		C/C 725	HP 1140
		C/C 900	HP 3140
	290	C/C 516	TO 0120
		C/C 725	TO 5110
		C/C 900	TO 5120
	290	C/C 516	TO 0320
		C/C 725	TO 5310
		C/C 900	TO 5320
	252	C/C 516	TH 0110
		C/C 725	TH 1110
		C/C 900	TH 3110
	252	C/C 516	HP 0110-U
		C/C 725	HP 1110-U
		C/C 900	HP 3110-U

## TILLBEHÖR 290 ACCESSORIES 290

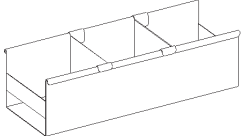
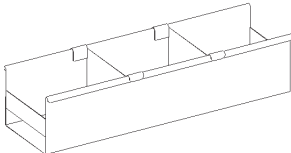
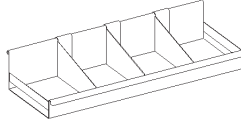
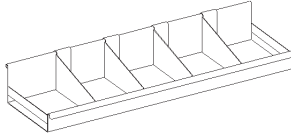
BOXAR/COMPARTMENTS	BESKRIVNING/DESCRIPTION	
	Bredd/Width	Art.nr/Art.no
	<b>BOKTRÅG</b>	C/C 725 TO 3517
	<b>BOOK COMPARTMENT</b>	
	<b>BOKTRÅG</b>	C/C 900 TO 3518
	<b>BOOK COMPARTMENT</b>	
	<b>CD-HYLLA</b>	C/C 725 TO 3617
	<b>CD-COMPARTMENT</b>	
	<b>CD-HYLLA</b>	C/C 900 TO 3618
	<b>CD-COMPARTMENT</b>	

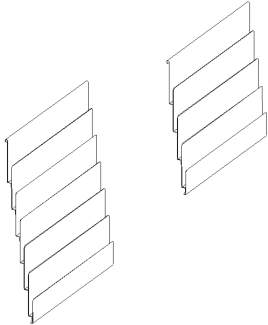
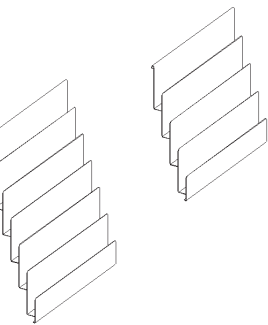
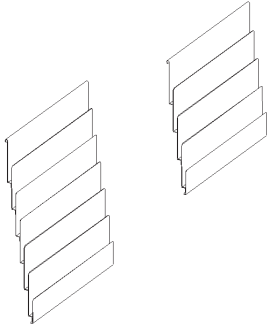
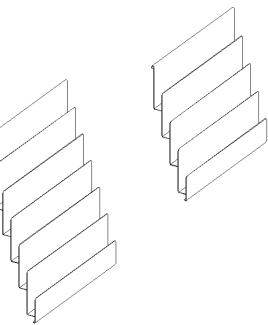
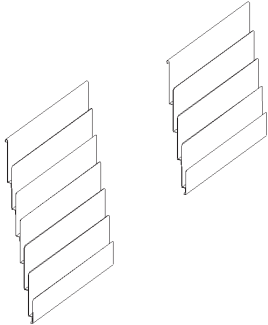
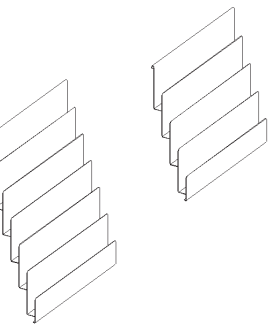
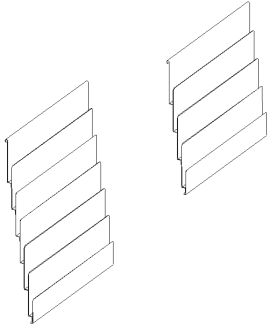
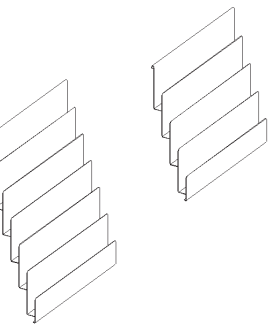
TIDSKRIFTS EXPO/PARTITIONS	BESKRIVNING/DESCRIPTION		
	Bredd/Width	Art.nr/Art.no	
	<b>TIDSKRIFTS EXPO</b>	4 FACK 19 MM	C/C 725 TO 2310
		HÖJD 645 MM (9 MODULER)	C/C 900 TO 2330
	<b>PERIODICAL DISPLAY</b>	4 COMPARTMENT 19 MM	
		H. 645 MM (9 MODULS)	
	<b>TIDSKRIFTS EXPO</b>	6 FACK 19 MM	C/C 725 TO 2311
		HÖJD 885 MM (13 MODULER)	C/C 900 TO 2331
	<b>PERIODICAL DISPLAY</b>	6 COMPARTMENT 19 MM	
		H. 885 MM (13 MODULES)	
	<b>TIDNINGS EXPO</b>	4 FACK 39 MM	
		HÖJD 645 MM (9 MODULER)	C/C 725 TO 2520
	<b>NEWSPAPER DISPLAY</b>	4 COMPARTMENT 39 MM	C/C 900 TO 2540
		H. 645 MM (9 MODULES)	
	<b>TIDNINGS EXPO</b>	6 FACK 39 MM	C/C 725 TO 2521
		HOJD 885 MM (13 MODULER)	C/C 900 TO 2541
	<b>NEWSPAPER DISPLAY</b>	6 COMPARTMENT 39 MM	
		H. 885 MM (13 MODULES)	

## TILLBEHÖR 290 ACCESSORIES 290

### SKYLTA/BOARDS

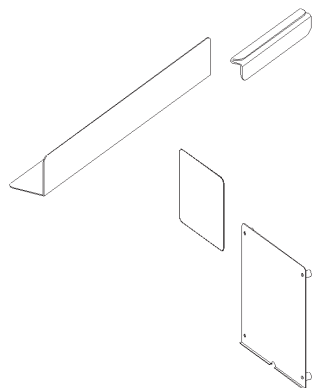

### BESKRIVNING/DESCRIPTION

	Mått/Dimensions	Art.nr/Art.no
FRAMKANTSSKYLT/TEXT STRIP FRONT EDGE	150x23	TO 1510
SEKTIONSSKYLT/TEXT STRIP SECTIONS	504x66	TO 1513
CD DISPLAY	150x140	TO 1520
GAVELSKYLT MED GLAS BOOK CASE END SIGN WITH GLASS	280x300	TO 1514

### EXPONERING/DISPLAY

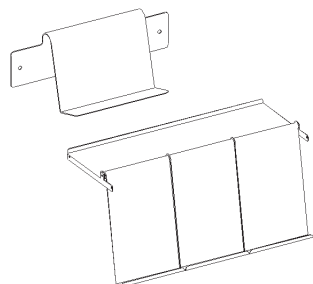

### BESKRIVNING/DESCRIPTION

	Mått/Dimensions	Art.nr/Art.no
GAVEEXPONERING ENKEL SINGLE BOOKCASE END DISPLAY	170x124	TO 1710
3-DELAT EXPOMAGASIN 3.PARTS EXPO-MAGAZINE	C/C 725	TO 1917
	C/C 900	TO 1918

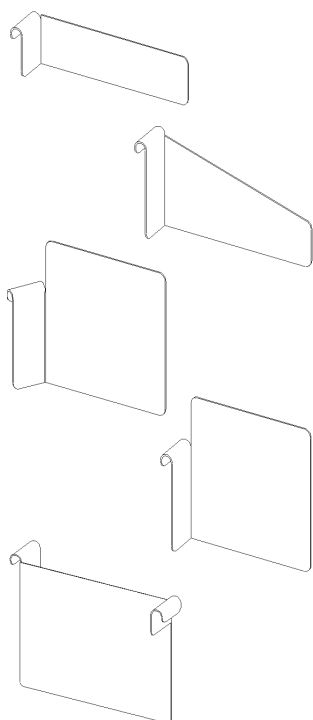

### HYLLAVDELARE/PARTITIONS



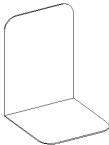
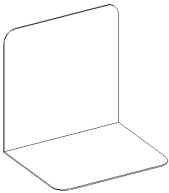

### BESKRIVNING/DESCRIPTION

	Mått/Dimensions	Art.nr/Art.no
HYLLAVDELARE FÖR LÅG BAKKANT PARTITION LOW	235x64	TO 4320
AVDELARE FÖR CD BOX PARTITION FOR CD BOX	235x120	TO 4322
HYLLAVDELARE 60° FÖR HÖG BAKKANT PARTITION, ANGLER 60°, HIGH	190x190	TO 4311
HYLLAVDELARE FÖR HÖG BAKKANT PARTITIONS HIGH	190x190	TO 4321
AVDELARE FÖR BOKTRÅG PARTITIONS COMPARTMENT	237x185	TO 3519

## TILLBEHÖR 290 ACCESSORIES 290

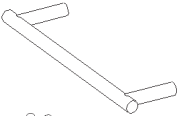
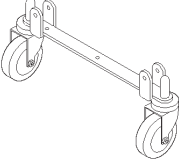
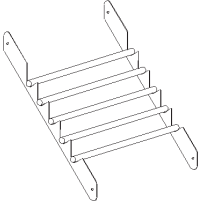
<b>BOKSTÖD/BOOKENDS</b>	<b>BESKRIVNING/DESCRIPTION</b>	
	<b>Mått/Dimensions</b>	<b>Art.nr/Art.no</b>
	<b>HÄNGANDE BOKSTÖD AV TRÅD</b>	220x120 TO 1310
	<b>HANGING BOOKENDS</b>	
	<b>BOKSTÖD - PLÅT</b>	200x150 TO 1312
	<b>BOOKENDS</b>	
	<b>BOKSTÖD - PLÅT A4</b>	250x200 TO 1313
	<b>BOOKENDS A4</b>	
	<b>FALLPLÅT</b>	252x80 TO 1320
	<b>METAL SHEET SINGLE</b>	
	<b>FALLTRÅD</b>	252 TO 1323
	<b>METAL ROD</b>	

<b>ÖVRIGT/OTHERS</b>	<b>BESKRIVNING/DESCRIPTION</b>	
	<b>Mått/Dimensions</b>	<b>Art.nr/Art.no</b>
	<b>HANDTAG ENKEL</b>	290x60 TO 1130
	<b>HANDLE SINGLE</b>	
	<b>HJULSÄT, SKENA &amp; HJUL, 2 PAR</b>	290x100 TO 4710-1
	<b>WHEEL SET, BAND &amp; WHEELS, 2 PAIRS</b>	
	<b>TIDNINGSHÄNGARE</b>	C/C 725 TO 2610
	<b>NEWSPAPER DISPLAY</b>	C/C 900 TO 2630
	<b>SKRIVSKIVA/WRITING TOP:</b>	
	<b>MASSIV AL/SOLID ALDER</b>	C/C 725 TO 1120-1
		C/C 900 TO 1120-2
	<b>MASSIV BJÖRK/SOLID BIRCH</b>	C/C 725 TO 1320-1
		C/C 900 TO 1320-2

## TILLBEHÖR GAVLAR 374 ACCESSORIES END PANELS 374

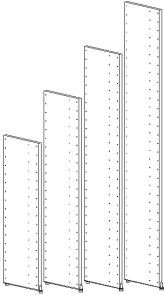
TRÄ/WOOD	BESKRIVNING/DESCRIPTION		
	Mått/Dimensions	Material	Art.nr/Art.no
	374x1084	AL/ALDER	G 3210-A1
		BJÖRK/BIRCH	G 3211-B1
	374x1404	AL/ALDER	G 3310-A1
		BJÖRK/BIRCH	G 3311-B1
	374x1724	AL/ALDER	G 3510-A1
		AL SKARV/JOINT ALDER	G 3510-B1
		BJÖRK/BIRCH	G 3511-B1
	374x2044	AL/ALDER	G 3710-A1
		AL SKARV/JOINT ALDER	G 3710-B1
		BJÖRK/BIRCH	G 3711-B1

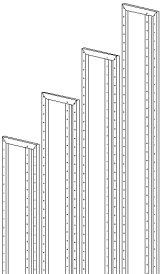
STÅL/STEEL	BESKRIVNING/DESCRIPTION		
	Mått/Dimensions	Material	Art.nr/Art.no
	374x1084	STÅL/STEEL	G 3210-S
	374x1404	STÅL/STEEL	G 3310-S
	374x1724	STÅL/STEEL	G 3510-S
	374x2044	STÅL/STEEL	G 3710-S

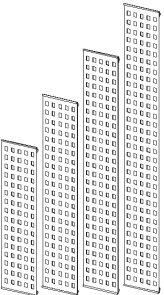
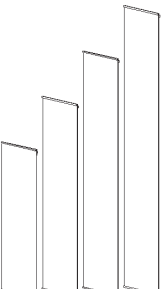
GAVELTÄCKNING/COVERING	BESKRIVNING/DESCRIPTION		
	Mått/Dimensions	Material	Art.nr/Art.no
	374x1084	PERFORERAD PLÅT/ PERFORATED STEEL	GF 3210-SP
	374x1404	PERFORERAD PLÅT/ PERFORATED STEEL	GF 3310-SP
	374x1724	PERFORERAD PLÅT/ PERFORATED STEEL	GF 3510-SP
	374x2044	PERFORERAD PLÅT/ PERFORATED STEEL	GF 3710-SP
	374x1084	FROSTAT GLAS/FROSTED GLASS	GF 3210-G2
	374x1404	FROSTAT GLAS/FROSTED GLASS	GF 3310-G2
	374x1724	FROSTAT GLAS/FROSTED GLASS	GF 3510-G2
	374x2044	FROSTAT GLAS/FROSTED GLASS	GF 3710-G2



## TILLBEHÖR 374 ACCESSORIES 374

### HYLLPLAN/SHELF

### BESKRIVNING/DESCRIPTION

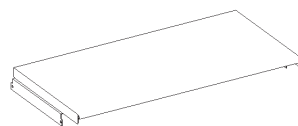
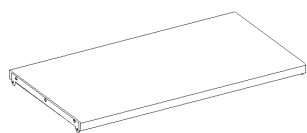
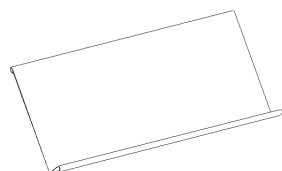
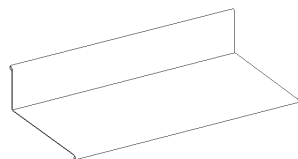

	Djup/Depth	Bredd/Width	Art.nr/Art.no
<b>HYLLPLAN</b>	336/64	C/C 516	HP 0510
<b>SHELVES</b>		C/C 725	HP 1510
		C/C 900	HP 3510
<b>HYLLPLAN</b>	336/128	C/C 516	HP 0530
<b>SHELVES</b>		C/C 725	HP 1530
		C/C 900	HP 3530
<b>TIDSKRIFTSHYLLA</b>	310/64	C/C 516	HP 0140
<b>MAGAZINE SHELVES</b>		C/C 725	HP 1140
		C/C 900	HP 3140
<b>KRÖNSKIVA MASSIV AL</b>	374	C/C 516	TO 0121
<b>TOPSHELF SOLID ALDER</b>		C/C 725	TO 5111
		C/C 900	TO 5121
<b>KRÖNSKIVA MASSIV BJÖRK</b>	374	C/C 516	TO 0321
<b>TOPSHELF SOLID BIRCH</b>		C/C 725	TO 5311
		C/C 900	TO 5321
<b>TOPPHYLLA STÅL</b>	336	C/C 516	TH 0510
<b>TOP SHELF STEEL</b>		C/C 725	TH 1510
		C/C 900	TH 3510
<b>UTDRAGSHYLLA</b>	336	C/C 516	HP 0510-U
<b>PULL OUT WRITING TOP</b>		C/C 725	HP 1510-U
		C/C 900	HP 3510-U

## TILLBEHÖR 374 ACCESSORIES 374

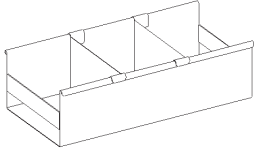
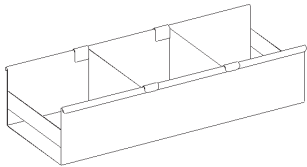
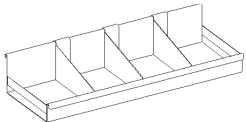
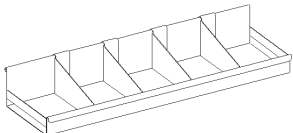
BOXAR	BESKRIVNING/DESCRIPTION		
	Djup/Depth	Bredd/Width	Art.nr/Art.no
	<b>BOKTRÅG</b>	336/192	C/C 725 TO 3510
	<b>BOOK COMPARTMENT</b>		
	<b>BOKTRÅG</b>	336/192	C/C 900 TO 3511
	<b>BOOK COMPARTMENT</b>		
	<b>CD-HYLLA</b>	336/128	C/C 725 TO 3610
	<b>CD-COMPARTMENT</b>		
	<b>CD-HYLLA</b>	336/128	C/C 900 TO 3611
	<b>CD-COMPARTMENT</b>		

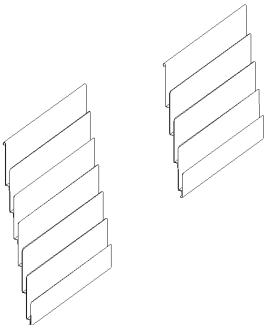
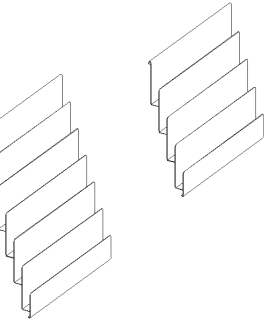
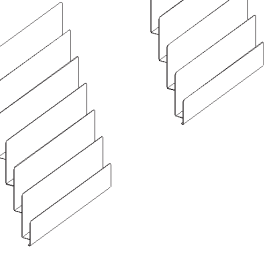
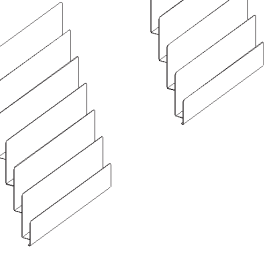
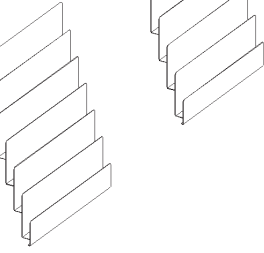
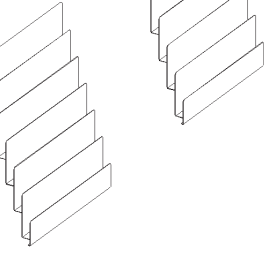
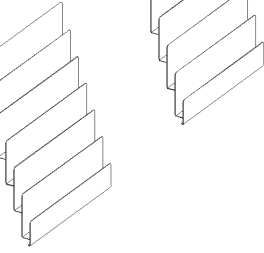
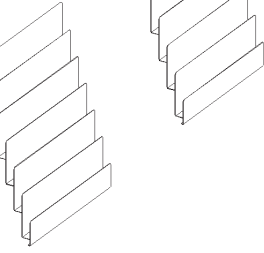
TIDSKRIFTS EXPO/PARTITIONS	BESKRIVNING/DESCRIPTION		
		Bredd/Width	Art.nr/Art.no
	<b>TIDSKRIFTS EXPO</b>	4 FACK 19 MM	C/C 725 TO 2310
		HÖJD 645 MM (9 MODULER)	C/C 900 TO 2330
	<b>PERIODICAL DISPLAY</b>	4 COMPARTMENT 19 MM	
		H. 645 MM (9 MODELS)	
	<b>TIDSKRIFTS EXPO</b>	6 FACK 19 MM	C/C 725 TO 2311
		HÖJD 885 MM (13 MODULER)	C/C 900 TO 2331
	<b>PERIODICAL DISPLAY</b>	6 COMPARTMENT 19 MM	
		H. 645 MM (13 MODULES)	
	<b>TIDNINGS EXPO</b>	4 FACK 39 MM	C/C 725 TO 2520
		HÖJD 645 (9 MODULER)	C/C 900 TO 2540
	<b>NEWSPAPER DISPLAY</b>	4 COMPARTMENT 39 MM	
		H.645 MM (9 MODULES)	
	<b>TIDNINGSEXPO</b>	6 FACK 39 MM	C/C 725 TO 2521
		HÖJD 885 MM (13 MODULER)	C/C 900 TO 2541
	<b>NEWSPAPER DISPLAY</b>	6 COMPARTMENT 39 MM	
		H. 885 MM (13 MODULES)	

## TILLBEHÖR 374 ACCESSORIES 374

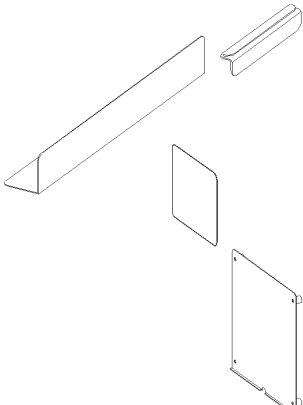
SKYLtar/BOARDS	BESKRIVNING/DESCRIPTION	
	Mått/Dimensions	Art.nr/Art.no
	FRAMKANTSSKYLT/TEXT STRIP FRONT EDGE	150x23 TO 1510
	SEKTIONSSKYLT/TEXT STRIP SECTIONS	504x66 TO 1513
	CD DISPLAY	150x140 TO 1520
	GAVELSKYLT MED GLAS	280x300 TO 1514
	BOOK CASE END SIGN WITH GLASS	

EXPONERING/DISPLAY	BESKRIVNING/DESCRIPTION	
	Mått/Dimensions	Art.nr/Art.no
	GAVEEXPONERING ENKEL	254x124 TO 1712
	SINGLE BOOKCASE END DISPLAY	

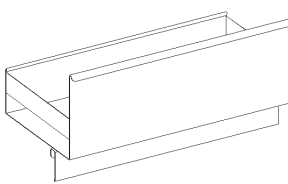
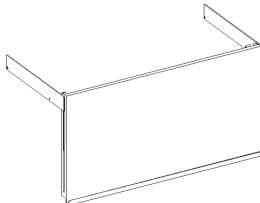
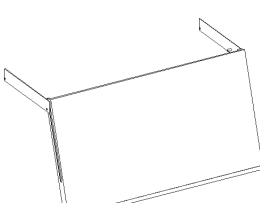

MAGASIN	BESKRIVNING/DESCRIPTION		
	Mått/Dimensions	Bredd/Width	Art.nr/Art.no
	TILTBOX	H. 384 MM C/C 725	TO 2110
	TILT BOX	(6 MODULER)/ C/C 900	TO 2111
		(6 PARTS)	
	EXPOMAGASIN	H. 384 MM C/C 725	TO 1911
	EXPO-MAGZINE	(6 MODULER)/ C/C 900	TO 1913
		(6 PARTS)	
	EXPOMAGASIN 30 MM	H. 384 MM C/C 725	TO 1914
	EXPO-MAGAZINE 30 MM	(6 MODULER)/ C/C 900	TO 1916
		(6 PARTS)	

## TILLBEHÖR 374 ACCESSORIES 374

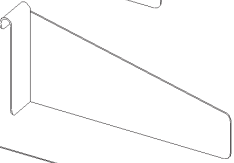
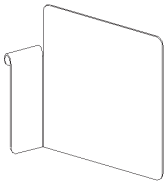
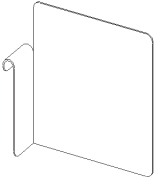
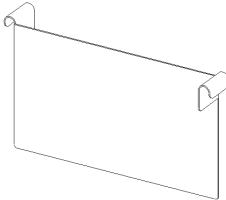
### HYLLAVDELARE/PARTITIONS BESKRIVNING/DESCRIPTION

	Mått/Dimensions Art.nr/Art.no	
	HYLLAVDELARE FÖR LÅG BAKKANT	319x64 TO 4319
	PARTITION LOW	
	AVDELARE FÖR CD BOX	319x128 TO 4323
	PARTITION FOR CD BOX	
	HYLLAVDELARE 60° FÖR HÖG BAKKANT	190x190 TO 4311
	PARTITION, ANGLER 60°, HIGH	
	HYLLAVDELARE FÖR HÖG BAKKANT	190x190 TO 4321
	PARTITIONS HIGH	
	AVDELARE FÖR BOKTRÅG	320x185 TO 3520
	PARTITIONS COMPARTMENT	

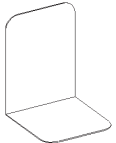
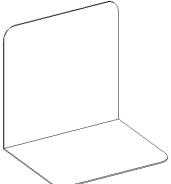
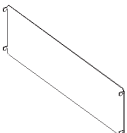
### BOKSTÖD/BOOKENDS BESKRIVNING/DESCRIPTION

	Mått/Dimensions Art.nr/Art.no	
	HÄNGANDE BOKSTÖD AV TRÅD	220x120 TO 1310
	HANGING BOOKENDS	
	BOKSTÖD - PLÅT	200x150 TO 1312
	BOOKENDS	
	BOKSTÖD - PLÅT A4	250x200 TO 1313
	BOOKENDS A4	
	FALLPLÅT	336x80 TO 1321
	METAL ROD	
	FALLTRÅD	252 TO 1323
	METAL SHEET SINGLE	

# TILLBEHÖR 374 ACCESSORIES 374

## ÖVRIGT/OTHERS

## BESKRIVNING/DESCRIPTION

Mått/Dimensions Art.nr/Art.no

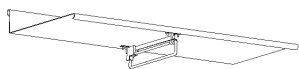

**GARDEROBSUTDRAG INKL. HYLLPLAN** C/C 725 HP 1510-2

**WARDROBE EXTENSION INL. SHELF** C/C 900 HP 3510-2

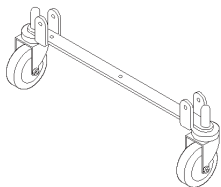

**HJULSATS, SKENA & HJUL, 2 PAR** 374x100 TO 4710-2

**WHEEL SET, BAND & WHEELS, 2 PAIRS**

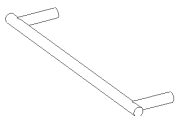

**HANDTAG 374, ENKEL** 374x60 TO 1131

**HANDLE 374, SINGLE**

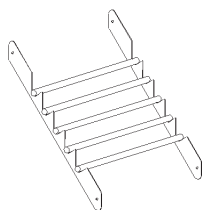

**TIDNINGSHÄNGARE** C/C 725 TO 2610

**NEWSPAPER DISPLAY** C/C 900 TO 2630

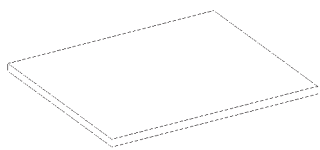

**SKRIVSKIVA/WRITING TOP:**

**MASSIV AL/SOLID ALDER** C/C 725 TO 1120-1

C/C 900 TO 1120-2

**MASSIV BJÖRK/SOLID BIRCH** C/C 725 TO 1320-1

C/C 900 TO 1320-2

## TILLBEHÖR GAVLAR 542 ACCESSORIES END PANELS 542

### TRÄ/WOOD

### BESKRIVNING/DESCRIPTION

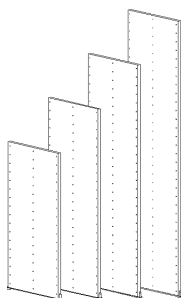

Mått/Dimensions	Material	Art.nr/Art.no
542x1084	AL/ALDER	G 5210-A1
	BJÖRK/BIRCH	G 5211-B1
542x1404	AL/ALDER	G 5310-A1
	BJÖRK/BIRCH	G 5311-B1
542x1724	AL/ALDER	G 5510-A1
	AL SKARV/JOINT ALDER	G 5510-B1
542x2044	BJÖRK/BIRCH	G 5511-B1
	AL/ALDER	G 5710-A1
542x2044	AL SKARV/JOINT ALDER	G 5710-B1
	BJÖRK/BIRCH	G 5711-B1

### STÅL/STEEL

### BESKRIVNING/DESCRIPTION

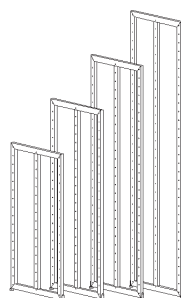

Mått/Dimensions	Material	Art.nr/Art.no
542x1084	STÅL/STEEL	G 5210-S
542x1404	STÅL/STEEL	G 5310-S
542x1724	STÅL/STEEL	G 5510-S
542x2044	STÅL/STEEL	G 5710-S

### GAVELTÄCKNING/COVERING

### BESKRIVNING/DESCRIPTION

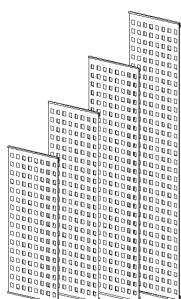

Mått/Dimensions	Material	Art.nr/Art.no
542x1084	PERFORERAD PLÅT/ PERFORATED STEEL	GF 5210-SP
	PERFORERAD PLÅT/ PERFORATED STEEL	GF 5310-SP
542x1404	PERFORERAD PLÅT/ PERFORATED STEEL	GF 5510-SP
	PERFORERAD PLÅT/ PERFORATED STEEL	GF 5710-SP
542x1084	FROSTAT GLAS/FROSTED GLASS	GF 5210-G2
	FROSTAT GLAS/FROSTED GLASS	GF 5310-G2
542x1724	FROSTAT GLAS/FROSTED GLASS	GF 5510-G2
542x2044	FROSTAT GLAS/FROSTED GLASS	GF 5710-G2

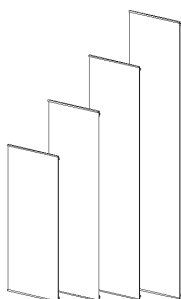

## TILLBEHÖR 542 ACCESSORIES 542

### HYLLPLAN/SHELF

### BESKRIVNING/DESCRIPTION

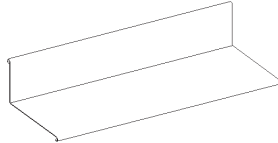
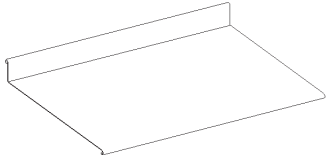
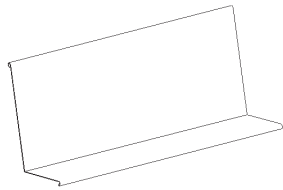
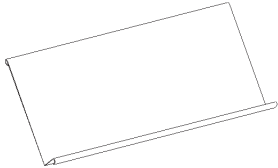
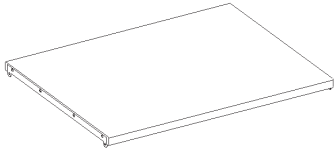
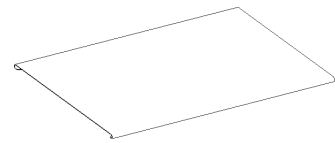
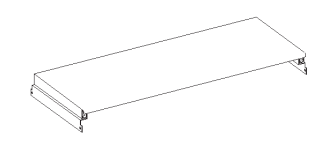
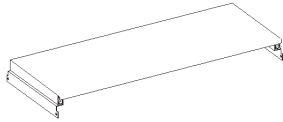
	Djup/Depth	Bredd/Width	Art.nr/Art.no
	252/64	C/C 516	HP 0110
		C/C 725	HP 1110
		C/C 900	HP 3110
	252/128	C/C 516	HP 0130
		C/C 725	HP 1130
		C/C 900	HP 3130
	504/64	C/C 725	HP 1150
		C/C 900	HP 3150
	192/304	C/C 725	HP 1170
		C/C 900	HP 3170
	310/64	C/C 516	HP 0140
		C/C 725	HP 1140
		C/C 900	HP 3140
	542	C/C 725	TO 5112
		C/C 900	TO 5122
	542	C/C 725	TO 5312
		C/C 900	TO 5322
	504	C/C 725	TH 1120
		C/C 900	TH 3120
	252	C/C 516	HP 0110-U
		C/C 725	HP 1110-U
		C/C 900	HP 3110-U

## TILLBEHÖR 542 ACCESSORIES 542

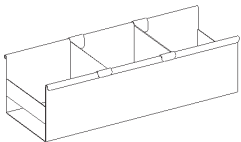
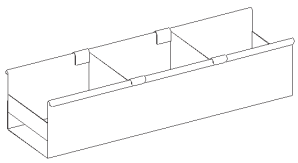
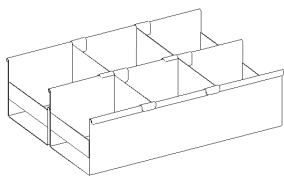
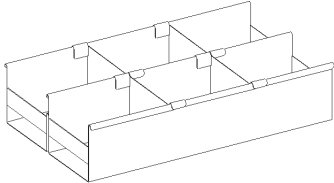
BOXAR/BOXES	BESKRIVNING/DESCRIPTION		
	Djup/Depth	Bredd/Width	Art.nr/Art. no
	<b>BOKTRÅG</b>	252/192	C/C 725 TO 3517
	<b>BOOK COMPARTMENT</b>		
	<b>BOKTRÅG</b>	252/192	C/C 900 TO 3518
	<b>BOOK COMPARTMENT</b>		
	<b>BOKTRÅG</b>	252/192	C/C 725 TO 3517
	<b>BOOK COMPARTMENT</b>	252/128	TO 3515
	<b>BOKTRÅG</b>	252/192	C/C 900 TO 3518
	<b>BOOK COMPARTMENT</b>	252/128	TO 3516

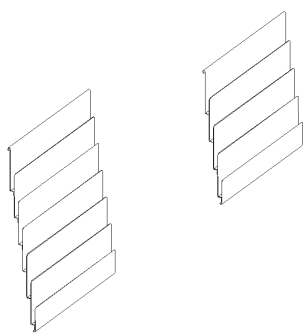
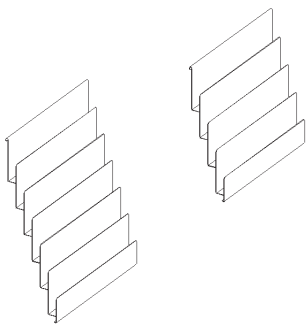
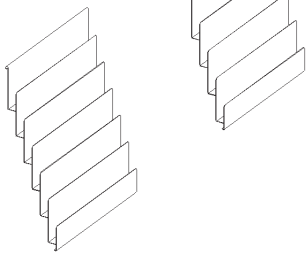
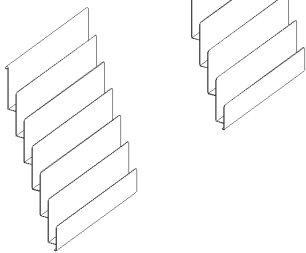
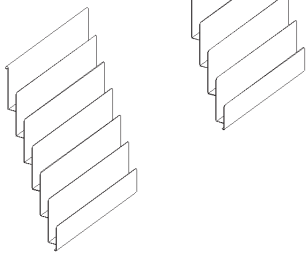
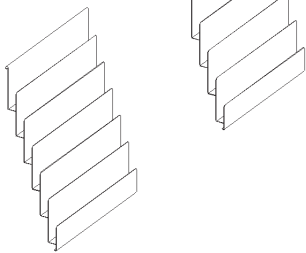
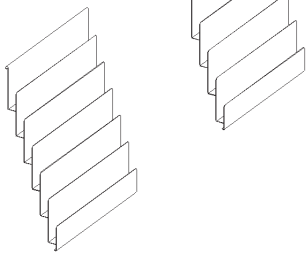
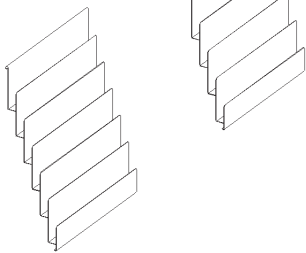
DISPLAY	BESKRIVNING/DESCRIPTION		
		Bredd/Width	Art.nr/Art.no
	<b>TIDSKRIFTS EXPO</b>	4 FACK 19 MM	C/C 725 TO 2310
		HÖJD 645 MM (9 MODULER)	C/C 900 TO 2330
	<b>PERIODICAL DISPLAY</b>	4 COMPARTMENT 19 MM	
		H. 645 MM (9 MODELS)	
	<b>TIDSKRIFTS EXPO</b>	6 FACK 19 MM	C/C 725 TO 2311
		HÖJD 885 MM (13 MODULER)	C/C 900 TO 2331
	<b>PERIODICAL DISPLAY</b>	6 COMPARTMENT 19 MM	
		H. 885 MM (13 MODULES)	
	<b>TIDNINGS EXPO</b>	4 FACK 39 MM	C/C 725 TO 2520
		HÖJD 645 MM (9 MODULER)	C/C 900 TO 2540
	<b>NEWSPAPER DISPLAY</b>	4 COMPARTMENT 39 MM	
		H. 645 MM (9 MODULES)	
	<b>TIDNINGSEXPO</b>	6 FACK 39 MM	C/C 725 TO 2521
		HÖJD 885 MM (13 MODULER)	C/C 900 TO 2541
	<b>NEWSPAPER DISPLAY</b>	6 COMPARTMENT 39 MM	
		H. 885 MM (13 MODULES)	



## TILLBEHÖR 542 ACCESSORIES 542

### CD-BOX

### BESKRIVNING/DESCRIPTION

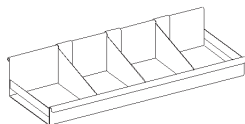

	Djup/Depth	Bredd/Width	Art.nr/Art.no
CD-HYLLA	252/128	C/C 725	TO 3617
CD-COMPARTMENT			

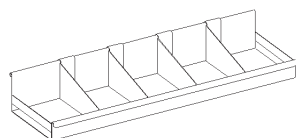

CD-HYLLA	252/128	C/C 900	TO 3618
CD-COMPARTMENT			

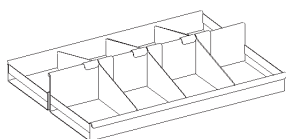

CD-HYLLA	252/128	C/C 725	TO 3617
CD-COMPARTMENT	252/64		TO 3619

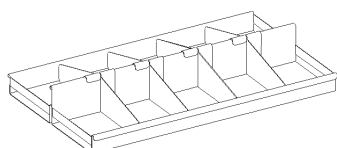

CD-HYLLA	252/128	C/C 900	TO 3618
CD-COMPARTMENT	252/64		TO 3620

### SKYLtar/BOARDS

### BESKRIVNING/DESCRIPTION

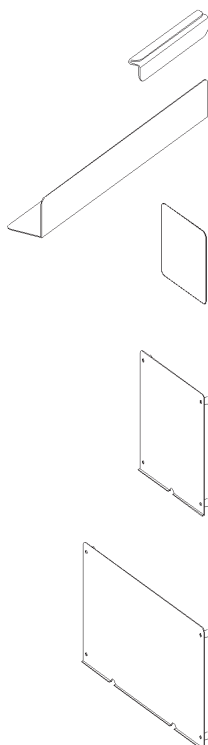

	Mått/Dimensions	Art.nr/Art.no
FRAMKANTSSKYLT/TEXT STRIP FRONT EDGE	150x23	TO 1510
SEKTIONSSKYLT/TEXT STRIP SECTIONS	504x66	TO 1513
CD DISPLAY	150x140	TO 1520
GAVELSKYLT MED GLAS BOOK CASE END SIGN WITH GLASS	280 X 300	TO 1514
GAVELSKYLT MED GLAS BOOK CASE END SIGN WITH GLASS	280 X 532	TO 1515

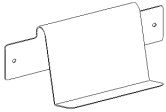
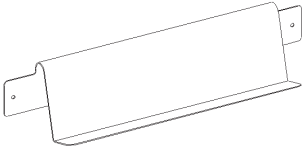
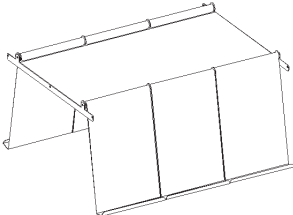

## TILLBEHÖR 542 ACCESSORIES 542

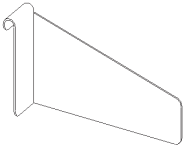
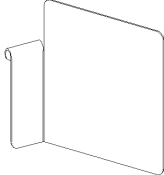
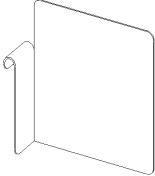
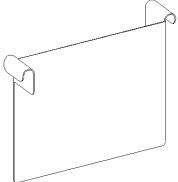
EXPONERING	BESKRIVNING/DESCRIPTION	
	Mått/Dimensions	Art.nr/Art.no
	GAVEEXPONERING ENKEL	170x124 TO 1710
	SINGLE BOOKCASE END DISPLAY	
	GAVEEXPONERING DUBBEL	422x124 TO 1711
	DOUBLE BOOKCASE END DISPLAY	
	3-DELAT EXPOMAGASIN	C/C 725 TO 1919
	3.PARTS EXPOMAGAZINE	C/C 900 TO 1920

HYLLAVDELARE/PARTITIONS	BESKRIVNING/DESCRIPTION	
	Mått/Dimensions	Art.nr/Art.no
	HYLLAVDELARE FÖR LÅG BAKKANT	235x64 TO 4320
	PARTITION LOW	
	AVDELARE FÖR CD-BOX	235x128 TO 4322
	PARTITION FOR CD-BOX	
	HYLLAVDELARE 60° FÖR HÖG BAKKANT	190x190 TO 4311
	PARTITION, ANGLER 60°, HIGH	
	HYLLAVDELARE FÖR HÖG BAKKANT	190x190 TO 4321
	PARTITIONS HIGH	
	AVDELARE FÖR BOKTRÅG	237x185 TO 3519
	PARTITIONS COMPARTMENT	

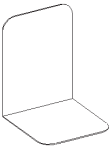
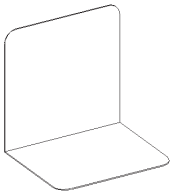
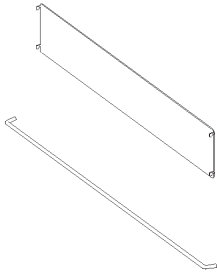
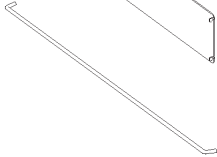
## TILLBEHÖR 542 ACCESSORIES 542

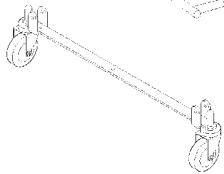
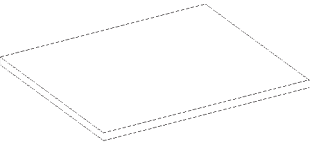
BOKSTÖD/BOOKENDS		BESKRIVNING/DESCRIPTION	
		Mått/Dimensions	Art.nr./Art.no
	HÄNGANDE BOKSTÖD AV TRÅD	220x120	TO 1310
	HANGING BOOKENDS		
	BOKSTÖD - PLÅT	200x150	TO 1312
	BOOKENDS		
	BOKSTÖD - PLÅT A4	250x200	TO 1313
	BOOKENDS - A4		
	FALLPLÅT/METAL SHEET DUBBEL/DOUBLE	504x80	TO 1322
	ENKEL/SINGLE	252x80	TO 1320
	FALLTRÅD	DUBBEL/DOUBLE 504	TO 1324
	METAL ROD	ENKEL/SINGLE 252	TO 1323

ÖVRIGT/OTHERS		BESKRIVNING/DESCRIPTION	
		Mått/Dimensions	Art.nr./Art.no
	HANDTAG DUBBEL	542x60	TO 1132
	HANDLE DOUBLE		
	HJULSATS, SKENA & HJUL, 2 PAR	542x100	TO 4710-3
	WHEEL SET, BAND & WHEELS, 2 PAIRS		
	SKRIVSKIVA/Writing TOP:		
	MASSIV AL/SOLID ALDER	C/C 725	TO 1120-1
		C/C 900	TO 1120-2
	MASSIV BJÖRK/SOLID BIRCH	C/C 725	TO 1320-1
	C/C 900	TO 1320-2	
	GAVELBORD MASSIV AL	542x700x900	TO 1121
	TABLE END SOLID ALDER		
	GAVELBORD MASSIV BJÖRK	542x700x900	TO 1421
	TABLE END SOLID BJÖRK		

## TILLBEHÖR ÖVRIGT ACCESSORIES OTHERS

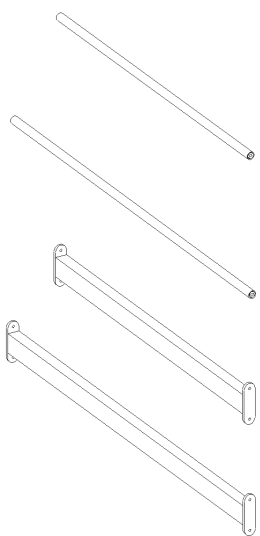
ÖVRIGT/OTHERS	BESKRIVNING/DESCRIPTION	Mått/Dimensions	Art.nr/Art.no
	KOPPLINGSRÖR/CONNECTION TUBE	C/C 725	TO 2110-1
	KOPPLINGSRÖR/CONNECTION TUBE	C/C 900	TO 2111-1
	KOPPLINGSBALK/CONNECTION BRACKET	C/C 725	TO 1100-1
	KOPPLINGSBALK/CONNECTION BRACKET	C/C 900	TO 1100-3

DETALJER/DETAILS		Mått/Dimensions	Art.nr/Art.no
	SKRUV/SCREW	M6x35	TO 5910
	BULT/BOLT	M6x32	TO 5911
	MUTTER/SOCKET	M6x20	TO 5912
	BESLAG/SCREW SOCKET		TO 5913
	SKARVBESLAG/JOINT BRACKET	C/C 38	TO 5914
	SKARVBESLAG/JOINT BRACKET	C/C 60	TO 5915
	KOPPLINGSVINKEL/CONNECTION ANGLE		TO 5917
	INSEXNYCKEL/ALOYN KEY		TO 5918
	VÄGGBESLAG/WALL BRACKET CONNECTOR		TO 5925





# TILLBEHÖR RYGGAR ACCESSORIES BACKS

## RYGGAR/BACKS C/C 725

## BESKRIVNING/DESCRIPTION

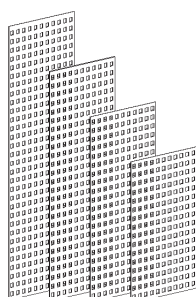
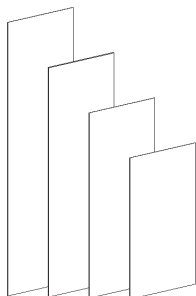

Gavelhöjd/ Endpanels height	Rygg höjd C/C Backheight C/C	Material	Art.nr/Art.no
1084	960	FROSTAT GLAS/FROSTED GLASS	TO 3010-07
1404	1280	FROSTAT GLAS/FROSTED GLASS	TO 3010-04
1724	1600	FROSTAT GLAS/FROSTED GLASS	TO 3010-05
2044	1920	FROSTAT GLAS/FROSTED GLASS	TO 3010-06
1084	960	PERFORERAD PLYWOOD/ PERFORATED PLYWOOD	TO 3010-17
		PERFORERAD PLÅT/ PERFORATED STEEL	TO 3010-37
1404	1280	PERFORERAD PLYWOOD/ PERFORATED PLYWOOD	TO 3010-14
		PERFORERAD PLÅT/ PERFORATED STEEL	TO 3010-34
1724	1600	PERFORERAD PLYWOOD/ PERFORATED PLYWOOD	TO 3010-15
		PERFORERAD PLÅT/ PERFORATED STEEL	TO 3010-35
2044	1920	PERFORERAD PLYWOOD/ PERFORATED PLYWOOD	TO 3010-16
		PERFORERAD PLÅT/ PERFORATED STEEL	TO 3010-36

# TILLBEHÖR RYGGAR ACCESSORIES BACKS

## RYGGAR/BACKS C/C 900

## BESKRIVNING/DESCRIPTION

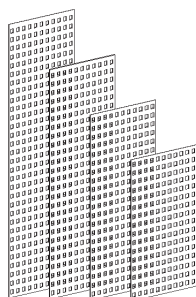
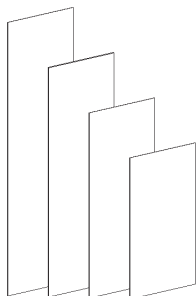

Gavelhöjd/ Endpanels height	Rygg höjd C/C Backheight C/C	Material	Art.nr/Art.no
1084	960	FROSTAT GLAS/FROSTED GLASS	TO 3011-07
1404	1280	FROSTAT GLAS/FROSTED GLASS	TO 3011-04
1724	1600	FROSTAT GLAS/FROSTED GLASS	TO 3011-05
2044	1920	FROSTAT GLAS/FROSTED GLASS	TO 3011-06
1084	960	PERFORERAD PLYWOOD/ PERFORATED PLYWOOD	TO 3011-17
		PERFORERAD PLÅT/ PERFORATED STEEL	TO 3011-37
1404	1280	PERFORERAD PLYWOOD/ PERFORATED PLYWOOD	TO 3011-14
		PERFORERAD PLÅT/ PERFORATED STEEL	TO 3011-34
1724	1600	PERFORERAD PLYWOOD/ PERFORATED PLYWOOD	TO 3011-15
		PERFORERAD PLÅT/ PERFORATED STEEL	TO 3011-35
2044	1920	PERFORERAD PLYWOOD/ PERFORATED PLYWOOD	TO 3011-16
		PERFORERAD PLÅT/ PERFORATED STEEL	TO 3011-36





## BOKTRÅG/BOOK BOXES

Gavlar i al, björk eller stål, inkl. hyllplan och boxar  
Endpanels in alder, birch or steel, incl. shelves and boxes

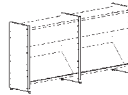

### 290/700 STARTSEKTION

Bredd/Width	Art.nr/Art.no
	<b>AL/ALDER</b>
C/C 725	BS 2910110
C/C 900	BS 2910210
	<b>BJÖRK/BIRCH</b>
C/C 725	BS 2910120
C/C 900	BS 2910220

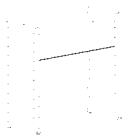

### PLUSSEKTION

Bredd/Width	Art.nr/Art.no
	<b>AL/ALDER</b>
C/C 725	BP 2910110
C/C 900	BP 2910210
	<b>BJÖRK/BIRCH</b>
C/C 725	BP 2910120
C/C 900	BP 2910220

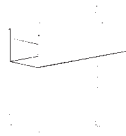

### 290/700

	<b>AL/ALDER</b>
C/C 725	BS 2911110
C/C 900	BS 2911210
	<b>BJÖRK/BIRCH</b>
C/C 725	BS 2911120
C/C 900	BS 2911220

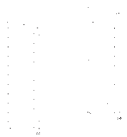

	<b>AL/ALDER</b>
C/C 725	BP 2911110
C/C 900	BP 2911210
	<b>BJÖRK/BIRCH</b>
C/C 725	BP 2911120
C/C 900	BP 2911220

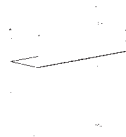

### 290/700

	<b>STÅL/STEEL</b>
C/C 725	BS 2910150
C/C 900	BS 2910250

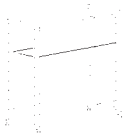

	<b>STÅL/STEEL</b>
C/C 725	BP 2910150
C/C 900	BP 2910250

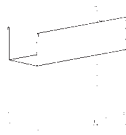

### 290/700

	<b>STÅL/STEEL</b>
C/C 725	BS 2911150
C/C 900	BS 2911250



	<b>STÅL/STEEL</b>
C/C 725	BP 2911150
C/C 900	BP 2911250

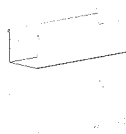

#### TILLBEHÖR STÅL/ACCESSORIES STEEL:

Gavelsida av frostat glas GF 2901-G2

Gavelsida av perforerad plåt GF 2901-SP

Decorative covers in frosted tempered glass GF 2901-G2

Decorative covers in perforated sheet steel GF 2901-SP

## BOKTRÅG/BOOK BOXES

Gavlar i al, björk eller stål, inkl. hyllplan och boxar  
Endpanels in alder, birch or steel, incl. shelves and boxes

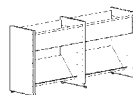

### 374/700 STARTSEKTION PLUSSEKTION

Bredd/Width	Art.nr/Art.no
<b>AL/ALDER</b>	
C/C 725	BS 3710110
C/C 900	BS 3710210
<b>BJÖRK/BIRCH</b>	
C/C 725	BS 3710120
C/C 900	BS 3710220

Bredd/Width	Art.nr/Art.no
<b>AL/ALDER</b>	
C/C 725	BP 3710110
C/C 900	BP 3710210
<b>BJÖRK/BIRCH</b>	
C/C 725	BP 3710120
C/C 900	BP 3710220

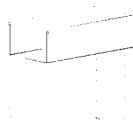
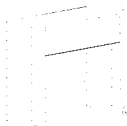

### 374/700

<b>AL/ALDER</b>	
C/C 725	BS 3711110
C/C 900	BS 3711210
<b>BJÖRK/BIRCH</b>	
C/C 725	BS 3711120
C/C 900	BS 3711220

<b>AL/ALDER</b>	
C/C 725	BP 3711110
C/C 900	BP 3711210
<b>BJÖRK/BIRCH</b>	
C/C 725	BP 3711120
C/C 900	BP 3711220

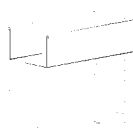
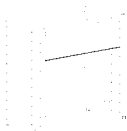

### 374/700

<b>STÅL/STEEL</b>	
C/C 725	BS 3710150
C/C 900	BS 3710250

<b>STÅL/STEEL</b>	
C/C 725	BP 3710150
C/C 900	BP 3710250

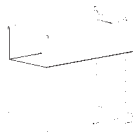
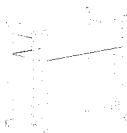

### 374/700

<b>STÅL/STEEL</b>	
C/C 725	BS 3711150
C/C 900	BS 3711250

<b>STÅL/STEEL</b>	
C/C 725	BP 3711150
C/C 900	BP 3711250

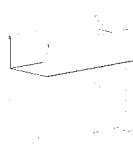
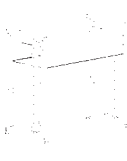

#### TILLBEHÖR STÅL/ACCESSORIES STEEL:

Gavelsida av frostat glas GF 3701-G2

Gavelsida av perforerad plåt GF 3701-SP

Decorative covers in frosted tempered glass GF 3701-G2

Decorative covers in perforated sheet steel GF 3701-SP

## BOKTRÅG/BOOK BOXES

Gavlar i al, björk eller stål inkl. hyllplan och boxar  
Endpanels in alder, birch or steel, incl. shelves and boxes

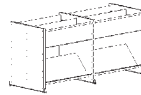

### 542/700 STARTSEKTION

Bredd/Width	Art.nr/Art.no
	<b>AL/ALDER</b>
C/C 725	BS 5410110
C/C 900	BS 5410210
	<b>BJÖRK/BIRCH</b>
C/C 725	BS 5410120
C/C 900	BS 5410220

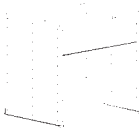

### PLUSSEKTION

Bredd/Width	Art.nr/Art.no
	<b>AL/ALDER</b>
C/C 725	BP 5410110
C/C 900	BP 5410210
	<b>BJÖRK/BIRCH</b>
C/C 725	BP 5410120
C/C 900	BP 5410220

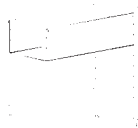

### 542/700

	<b>AL/ALDER</b>
C/C 725	BS 5411110
C/C 900	BS 5411210
	<b>BJÖRK/BIRCH</b>
C/C 725	BS 5411120
C/C 900	BS 5411220

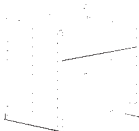

	<b>AL/ALDER</b>
C/C 725	BP 5411110
C/C 900	BP 5411210
	<b>BJÖRK/BIRCH</b>
C/C 725	BP 5411120
C/C 900	BP 5411220

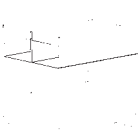

### 542/700

	<b>STÅL/STEEL</b>
C/C 725	BS 5410150
C/C 900	BS 5410250

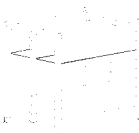

	<b>STÅL/STEEL</b>
C/C 725	BP 5410150
C/C 900	BP 5410250

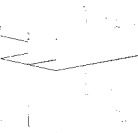

### 542/700

	<b>STÅL/STEEL</b>
C/C 725	BS 5411150
C/C 900	BS 5411250

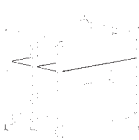

	<b>STÅL/STEEL</b>
C/C 725	BP 5411150
C/C 900	BP 5411250

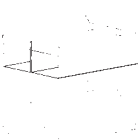

#### TILLBEHÖR STÅL/ACCESSORIES STEEL:

Gavelsida av frostat glas GF 5401-G2

Gavelsida av perforerad plåt GF 5401-SP

Decorative covers in frosted tempered glass GF 5401-G2

Decorative covers in perforated sheet steel GF 5401-SP

## CD/DVD/VIDEO - MEDIA

Gavlar i al, björk eller stål, inkl. hyllplan och CD display  
Endpanels in alder, birch or steel, incl. shelves and CD display



### 290/1084 STARTSEKTION

Bredd/Width	Art.nr/Art.no
<b>AL/ALDER</b>	
C/C 725	CDS 2910110
C/C 900	CDS 2910210
<b>BJÖRK/BIRCH</b>	
C/C 725	CDS 2910120
C/C 900	CDS 2910220



### PLUSSEKTION

Bredd/Width	Art.nr/Art.no
<b>AL/ALDER</b>	
C/C 725	CDP 2910110
C/C 900	CDP 2910210
<b>BJÖRK/BIRCH</b>	
C/C 725	CDP 2910120
C/C 900	CDP 2910220



### 374/1084

<b>AL/ALDER</b>	
C/C 725	CDS 3710110
C/C 900	CDS 3710210
<b>BJÖRK/BIRCH</b>	
C/C 725	CDS 3710120
C/C 900	CDS 3710220



<b>AL/ALDER</b>	
C/C 725	CDP 3710110
C/C 900	CDP 3710210
<b>BJÖRK/BIRCH</b>	
C/C 725	CDP 3710120
C/C 900	CDP 3710220

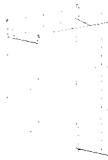

### 290/1084

<b>STÅL/STEEL</b>	
C/C 725	CDS 2910150
C/C 900	CDS 2910250



<b>STÅL/STEEL</b>	
C/C 725	CDP 2910150
C/C 900	CDP 2910250



#### TILLBEHÖR STÅL/ACCESSORIES STEEL:

Gavelsida av frostat glas	GF 1210-G2
Gavelsida av perforerad plåt	GF 1210-SP
Decorative covers in frosted tempered glass	GF 1210-G2
Decorative covers in perforated sheet steel	GF 1210-SP

### 374/1084

<b>STÅL/STEEL</b>	
C/C 725	CDS 3710150
C/C 900	CDS 3710250



<b>STÅL/STEEL</b>	
C/C 725	CDP 3710150
C/C 900	CDP 3710250



#### TILLBEHÖR STÅL/ACCESSORIES STEEL:

Gavelsida av frostat glas	GF 3210-G2
Gavelsida av perforerad plåt	GF 3210-SP
Decorative covers in frosted tempered glass	GF 3210-G2
Decorative covers in perforated sheet steel	GF 3210-SP

## CD/DVD/VIDEO - MEDIA

Gavlar i al, björk eller stål, inkl. hyllplan och CD display  
Endpanels in alder, birch or steel, incl. shelves and CD display

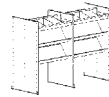

### 542/1084 STARTSEKTION

Bredd/Width	Art.nr/Art.no
<b>AL/ALDER</b>	
C/C 725	CDS 5410110
C/C 900	CDS 5410210
<b>BJÖRK/BIRCH</b>	
C/C 725	CDS 5410120
C/C 900	CDS 5410220

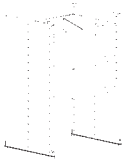

### PLUSSEKTION

Bredd/Width	Art.nr/Art.no
<b>AL/ALDER</b>	
C/C 725	CDP 5410110
C/C 900	CDP 5410210
<b>BJÖRK/BIRCH</b>	
C/C 725	CDP 5410120
C/C 900	CDP 5410220

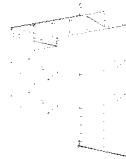

### 542/1084

<b>AL/ALDER</b>	
C/C 725	CDS 5411110
C/C 900	CDS 5411210
<b>BJÖRK/BIRCH</b>	
C/C 725	CDS 5411120
C/C 900	CDS 5411220

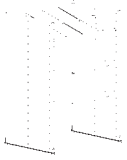

<b>AL/ALDER</b>	
C/C 725	CDP 5411110
C/C 900	CDP 5411210
<b>BJÖRK/BIRCH</b>	
C/C 725	CDP 5411120
C/C 900	CDP 5411220

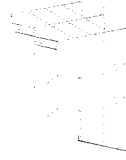

### 542/1084

<b>STÅL/STEEL</b>	
C/C 725	CDS 5410150
C/C 900	CDS 5410250



<b>STÅL/STEEL</b>	
C/C 725	CDP 5410150
C/C 900	CDP 5410250

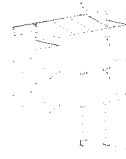

#### TILLBEHÖR STÅL/ACCESSORIES STEEL:

Gavelsida av frostat glas	GF 5210-G2
Gavelsida av perforerad plåt	GF 5210-SP
Decorative covers in frosted tempered glass	GF 5210-G2
Decorative covers in perforated sheet steel	GF 5210-SP

### 542/1084

<b>STÅL/STEEL</b>	
C/C 725	CDS 5411150
C/C 900	CDS 5411250



<b>STÅL/STEEL</b>	
C/C 725	CDP 5411150
C/C 900	CDP 5411250



#### TILLBEHÖR STÅL/ACCESSORIES STEEL:

Gavelsida av frostat glas	GF 5210-G2
Gavelsida av perforerad plåt	GF 5210-SP
Decorative covers in frosted tempered glass	GF 5210-G2
Decorative covers in perforated sheet steel	GF 5210-SP

## LÄSPLATSER/READING TABLES

Gavlar och skiva av al eller björk, front av stål/  
End panels and top in alder or birch, front in steel

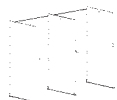

### 542x700 STARTSEKTION

LP 1	Bredd/width	Art.nr/Art.no
		<b>AL/ALDER</b>
	C/C 725	LLP 3110110
	C/C 900	LLP 3110210
		<b>BJÖRK/BIRCH</b>
	C/C 725	LLP 3110111
	C/C 900	LLP 3110211

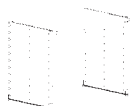

### PLUSSEKTION

Bredd/width	Art.nr/Art.no
	<b>AL/ALDER</b>
C/C 725	LLP 3120110
C/C 900	LLP 3120210
	<b>BJÖRK/BIRCH</b>
C/C 725	LLP 3120111
C/C 900	LLP 3120211

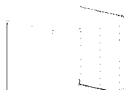

### 542x1084/700

LP 2	Bredd/width	Art.nr/Art.no
		<b>AL/ALDER</b>
	C/C 725	LLP 3210110
	C/C 900	LLP 3210210
		<b>BJÖRK/BIRCH</b>
	C/C 725	LLP 3210111
	C/C 900	LLP 3210211

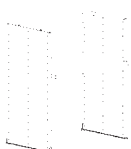

Bredd/width	Art.nr/Art.no
	<b>AL/ALDER</b>
C/C 725	LLP 3220110
C/C 900	LLP 3220210
	<b>BJÖRK/BIRCH</b>
C/C 725	LLP 3220111
C/C 900	LLP 3220211

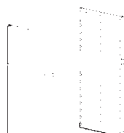

### 664x1084/700

LP 3	Bredd/width	Art.nr/Art.no
		<b>AL/ALDER</b>
	C/C 725	LLP 3310110
	C/C 900	LLP 3310210
		<b>BJÖRK/BIRCH</b>
	C/C 725	LLP 3310111
	C/C 900	LLP 3310211

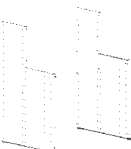

Bredd/width	Art.nr/Art.no
	<b>AL/ALDER</b>
C/C 725	LLP 3320110
C/C 900	LLP 3320210
	<b>BJÖRK/BIRCH</b>
C/C 725	LLP 3320111
C/C 900	LLP 3320211

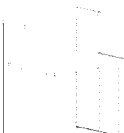

### 1038x1084/700

LP 4	Bredd/width	Art.nr/Art.no
		<b>AL/ALDER</b>
	C/C 725	LLP 3410110
	C/C 900	LLP 3410210
		<b>BJÖRK/BIRCH</b>
	C/C 725	LLP 3410111
	C/C 900	LLP 3410211

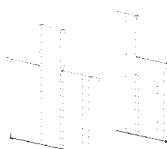

Bredd/width	Art.nr/Art.no
	<b>AL/ALDER</b>
C/C 725	LLP 3420110
C/C 900	LLP 3420210
	<b>BJÖRK/BIRCH</b>
C/C 725	LLP 3420111
C/C 900	LLP 3420211

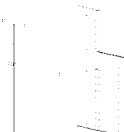





## STUDIEBORD/STUDY TABLES

Gavlar av al eller björk, skiva av vit laminat/End panels in alder or birch, top of white laminate

### STUDIEBORD/STUDY TABLES BESKRIVNING/DESCRIPTION

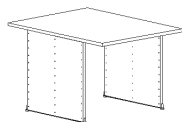

	Mått/Dimensions	Material	Art.nr/Art.no
STUDIEBORD 5	900x1200x720	AL/ALDER	LLP 3511810
STUDY TABLE 5		BJÖRK/BIRCH	LLP 3511811

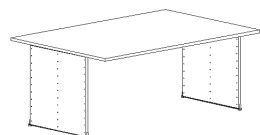

STUDIEBORD 5	1800x1200x720	AL/ALDER	LLP 3521810
STUDY TABLE 5		BJÖRK/BIRCH	LLP 3521811

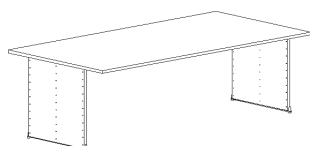

STUDIEBORD 5	2400x1200x720	AL/ALDER	LLP 3531810
STUDY TABLE 5		BJÖRK/BIRCH	LLP 3531811

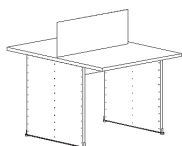

STUDIEBORD 6	900x1200x720	AL/ALDER	LLP 3611810
STUDY TABLE 6		BJÖRK/BIRCH	LLP 3611811

AVSKÄRMNING/ SCREEN OFF		FROSTAT GLAS/ FROSTED GLASS	
----------------------------	--	--------------------------------	--

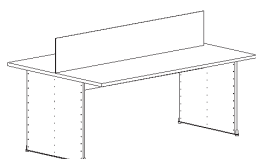

STUDIEBORD 6	1800x1200x720	AL/ALDER	LLP 3621810
STUDY TABLE 6		BJÖRK/BIRCH	LLP 3621811

AVSKÄRMNING/ SCREEN OFF		FROSTAT GLAS/ FROSTED GLASS	
----------------------------	--	--------------------------------	--

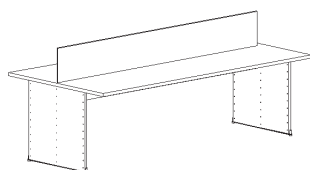

STUDIEBORD 6	2400x1200x720	AL/ALDER	LLP 3631810
STUDY TABLE 6		BJÖRK/BIRCH	LLP 3631811

AVSKÄRMNING/ SCREEN OFF		FROSTAT GLAS/ FROSTED GLASS	
----------------------------	--	--------------------------------	--

## STUDIEBORD/STUDY TABLES

Gavlar av stål, skiva av vit laminat/End panels in steel, top of white laminate

### STUDIEBORD/STUDY TABLES BESKRIVNING/DESCRIPTION

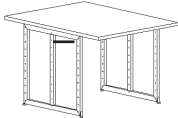
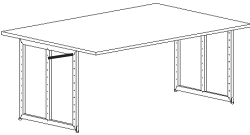
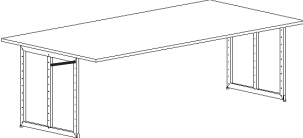
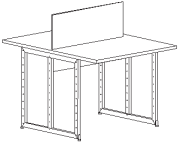
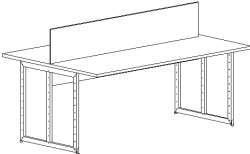
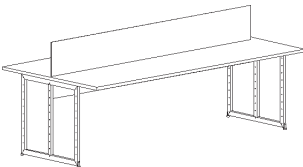
	Mått/Dimensions	Material	Art.nr/Art.no
	STUDIEBORD 5 900x1200x720 STUDY TABLE 5	STÅL/STEEL	LLP 3511850
	STUDIEBORD 5 1800x1200x720 STUDY TABLE 5	STÅL/STEEL	LLP 3521850
	STUDIEBORD 5 2400x1200x720 STUDY TABLE 5	STÅL/STEEL	LLP 3531850
	STUDIEBORD 6 900x1200x720 STUDY TABLE 6	STÅL/STEEL	LLP 3611850
	AVSKÄRMNING/ SCREEN OFF	FROSTAT GLAS/ FROSTED GLASS	
	STUDIEBORD 6 1800x1200x720 STUDY TABLE 6	STÅL/STEEL	LLP 3621850
	AVSKÄRMNING/ SCREEN OFF	FROSTAT GLAS/ FROSTED GLASS	
	STUDIEBORD 6 2400x1200x720 STUDY TABLE 6	STÅL/STEEL	LLP 3631850
	AVSKÄRMNING/ SCREEN OFF	FROSTAT GLAS/ FROSTED GLASS	
	<b>TILLBEHÖR STÅL/ACCESSORIES STEEL:</b>		
	Gavelsida av frostat glas	GF 8001-G2	
	Gavelsida av perforerad plåt	GF 8001-SP	
	Decorative covers in frosted tempered glass	GF 8001-G2	
	Decorative covers in perforated sheet steel	GF 8001-SP	

## BOKVAGNAR/BOOK TROLLEYS

### BOKVAGN/BOOK TROLLEYS BESKRIVNING/DESCRIPTION



	Mått/Dimensions	Material	Art.nr/Art.no
<b>MOBIL 1</b>	290/1084	<b>AL/ALDER</b>	LM 2910110
		<b>BJÖRK/BIRCH</b>	LM 2910111

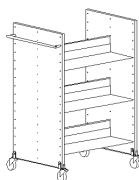

<b>MOBIL 2</b>	542/1084	<b>AL/ALDER</b>	LM 5410110
		<b>BJÖRK/BIRCH</b>	LM 5410111



<b>MOBIL 4</b>	290/1084	<b>AL/ALDER</b>	LM 2920110
		<b>BJÖRK/BIRCH</b>	LM 2920111

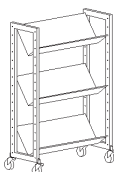

<b>MOBIL 1</b>	290/1084	<b>STÅL/STEEL</b>	LM 2910110-S
		<b>TILLBEHÖR STÅL/ACCESSORIES STEEL:</b>	
		Gavelsida av frostat glas	GF 1210-G2
		Gavelsida av perforerad plåt	GF 1210-SP
		Decorative covers in frosted tempered glass	GF 1210-G2
Decorative covers in perforated sheet steel	GF 1210-SP		

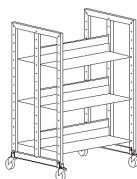

<b>MOBIL 2</b>	542/1084	<b>STÅL/STEEL</b>	LM 5410110-S
		<b>TILLBEHÖR STÅL/ACCESSORIES STEEL:</b>	
		Gavelsida av frostat glas	GF 5210-G2
		Gavelsida av perforerad plåt	GF 5210-SP
		Decorative covers in frosted tempered glass	GF 5210-G2
Decorative covers in perforated sheet steel	GF 5210-SP		

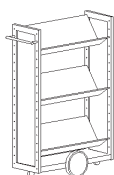

<b>MOBIL 4</b>	290/1084	<b>STÅL/STEEL</b>	LM 2920110-S
		<b>TILLBEHÖR STÅL/ACCESSORIES STEEL:</b>	
		Gavelsida av frostat glas	GF 1210-G2
		Gavelsida av perforerad plåt	GF 1210-SP
		Decorative covers in frosted tempered glass	GF 1210-G2
Decorative covers in perforated sheet steel	GF 1210-SP		



# BOKINKAST, FRÅGETERMINAL, DISK BOOK RETURN, PC TERMINAL TABLE, COUNTER

## BOKINKAST/BOOK RETURN BESKRIVNING/DESCRIPTION

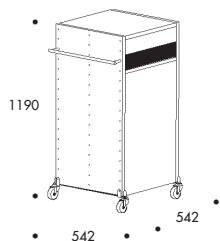

	Mått/Dimensions	Material	Art.nr/Art.no
<b>BOKINKAST 1/</b>	542x1190x542	<b>AL/ALDER</b>	LL 4110110
<b>VAGN</b>		<b>BJÖRK/BIRCH</b>	LL 4110111
<b>BOOK RETURN 1/</b>			
<b>TROLLEY</b>			

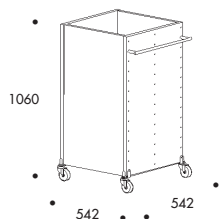

<b>BOKINKAST 2/</b>	542x1060x542	<b>AL/ALDER</b>	LL 4210110
<b>VAGN</b>		<b>BJÖRK/BIRCH</b>	LL 4210111
<b>BOOK RETURN 2/</b>			
<b>TROLLEY</b>			

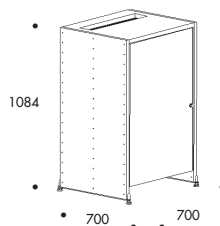

<b>GARAGE/INKAST</b>	700x1084x700	<b>AL/ALDER</b>	LL 4310110
<b>GARAGE/</b>		<b>BJÖRK/BIRCH</b>	LL 4310111
<b>BOOK RETURN/</b>			

## FRÅGETERMINAL/PC TERMINAL TABLE

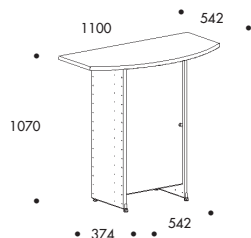

	Mått/Dimensions	Material	Art.nr/Art.no
<b>FRÅGETERMINAL</b>	374/542x1070x542/1100	<b>AL/ALDER</b>	LL 3110110
<b>TERMINAL TABLE</b>		<b>BJÖRK/BIRCH</b>	LL 3110111

## DISK/COUNTER

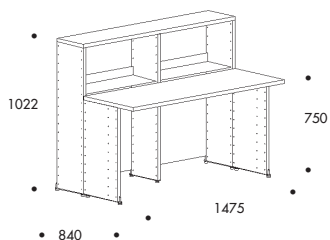

	Mått/Dimensions	Material	Art.nr/Art.no
<b>DISK</b>	840x750/1022x1475	<b>AL/ALDER</b>	LD 2910110
<b>COUNTER</b>		<b>BJÖRK/BIRCH</b>	LD 2910111

## MODULER/MODULES

### DUBBELSIDIG HYLLA MED GAVELSEKTION/ DOUBLESIDED UNIT WITH GABLE SECTIONS

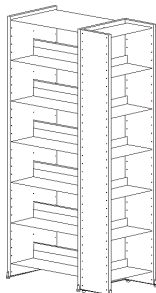

1 startsektion 542x2044	1 startunit 542x2044
1 startsektion 290x2044	1 startunit 290x2044

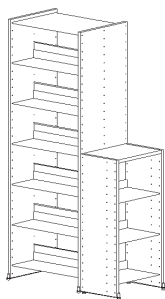

1 startsektion 542x2044	1 startunit 542x2044
1 startsektion 374x1084	1 startunit 374x1084

### TRAPPFORMATION/LEVEL FORMATION

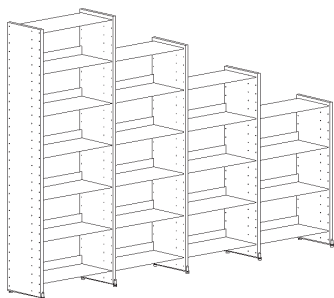

1 startsektion 374x2044	1 startunit 374x2044
1 plussektion 374x1724	1 plusunit 374x1724
1 plussektion 374x1404	1 plusunit 374x1404
1 plussektion 374x1084	1 plusunit 374x1084

### ZIC ZAC FORMATION/ZIC ZAC FORMATION

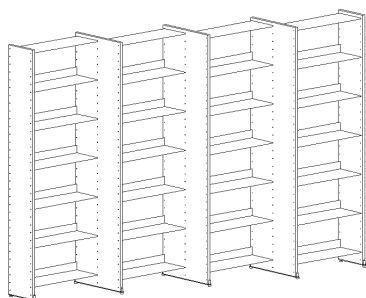





Gavlar med djupen 290 och 542. Kombinerade.	End panels combined with depth 290
Hyllplansdjup 252 mm.	and 542. Shelves depth 252 mm.
För snedställd placering mot vägg.	Placed diagonally against wall.

# TILLBEHÖR BELYSNING

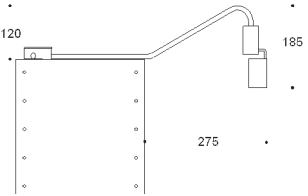
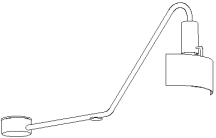
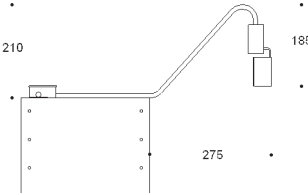
## ACCESSORIES LIGHTING FIXTURES

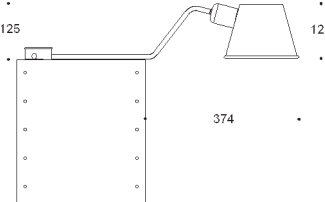
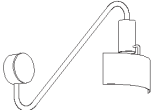



### BELYSNING/LIGHTING FIXTURES BESKRIVNING/DESCRIPTION

	Mått/Dimensions	Ljuskälla/Light source	Art.nr/Art.no
			
<b>BUSLIGHT 3115</b> Låg/Low	40W/E14	BU 3115	
<b>LJUSKÄLLA/LIGHT SOURCE E14/40W</b>		BU 3115-2	
			
			
<b>BUSLIGHT 3117</b> Hög/High	40W/E14	BU 3117	
<b>LJUSKÄLLA/LIGHT SOURCE E14/40W</b>		BU 3115-2	
			
			
<b>BUSLIGHT 3116</b>	75W/E27	BU 3116	
	PL15W/E14	BU 3116	
<b>LJUSKÄLLA/LIGHT SOURCE E27/75W</b>		BU 3116-2	
<b>LJUSKÄLLA/LIGHT SOURCE E27/PL15W</b>		BU 3116-3	
			
			
<b>BUSLIGHT 3118</b> Vägg/Wall	40W/E14	BU 3118	
<b>LJUSKÄLLA/LIGHT SOURCE E14/40W</b>		BU 3115-2	
			
<b>BUSLIGHT LIST</b>	450x35	PL7W	BU 3127
<b>BUSLIGHT PL7W</b>		BU 3129-1	
<b>BUSLIGHT PL9W</b>		BU 3129-2	
<b>BUSLIGHT PL11</b>		BU 3129-3	

# TILLBEHÖR BELYSNING

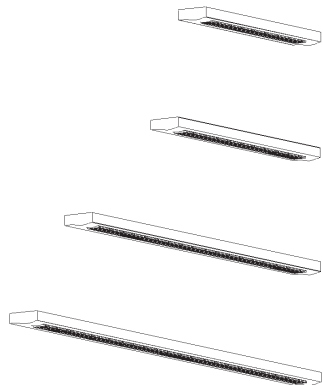
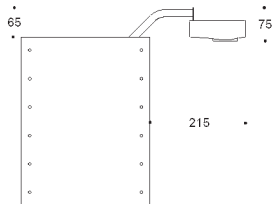
## ACCESSORIES LIGHTING FIXTURES

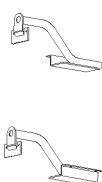
### BELYSNING/LIGHTING FIXTURES BESKRIVNING/DESCRIPTION

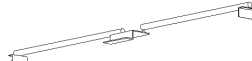
		Mått/Dimensions	Ljuskälla/Light source	Art.nr/Art.no
	<b>VIVA</b> Ned ljus Downlights	L. 725	14W/1xT5	7105138
	<b>VIVA</b> Ned ljus Downlights	L. 900	21W/1xT5	7105238
	<b>VIVA</b> Ned ljus Downlights	L. 1450	14W/1xT5	7105438
	<b>VIVA</b> Ned ljus Downlights	L. 1800	21W/1xT5	7105638
	<b>LYSRÖR/LIGHT SOURCE</b>		14W/T5	14W/T5
	<b>LYSRÖR/LIGHT SOURCE</b>		21W/T5	21W/T5
	<b>VIVA</b> Gavel vänster/Endpanel left			7318138
	<b>VIVA</b> Gavel höger/Endpanel right			7317138
	<b>VIVA</b> Rak koppling/Straight connection			7310138
	<b>VIVA</b> Beslag vänster/ Shelfbracket left			7307138
	<b>VIVA</b> Beslag höger/ Shelfbracket right			7306138
	<b>KOPPLINGSRÖR/BUSLIGHT</b> <b>CONNECTION TUBE/BUSLIGHT</b>	C/C 725		BU 3117-1
		C/C 900		BU 3117-2
	<b>MITTMONTAGE BUSLIGHT/Beslag</b> <b>BRACKET FOR CENTER MOUNTING</b>	C/C 725		BU 3117-3
	<b>ON TOPSHELF/BUSLIGHT</b>	C/C 900		BU 3117-4



# TILLBEHÖR BELYSNING ACCESSORIES LIGHTING FIXTURES

## BELYSNING/LIGHTING FIXTURES BESKRIVNING/DESCRIPTION

Mått/Dimensions Ljuskälla/Light source Art.nr/Art.no



<b>READY</b> Start vänster/left	L. 725	21W/T5	7360-1-86
Start höger/right		21W/T5	7361-1-86
Plus		21W/T5	7362-1-86

<b>READY</b> Start vänster/left	L. 900	21W/T5	7360-3-86
Start höger/right		21W/T5	7361-3-86
Plus		21W/T5	7362-3-86

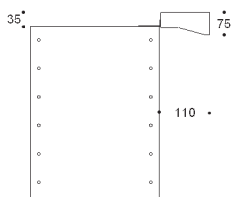

**READY**

**GAVEL VÄNSTER/END PANEL LEFT** 97360-1-86

**GAVEL HÖGER/END PANEL RIGHT** 97361-1-86

**HYLLFÄSTE/SHELFBRACKET** 97362-1-86

**READY START & PLUS**

